

# **Machinations: The Inductively Coupled Plasma/Mass Spectrometer (ICP/MS)**

D. F. Strong et H. P. Longerich

Volume 12, numéro 2, june 1985

URI : [https://id.erudit.org/iderudit/geocan12\\_2fea02](https://id.erudit.org/iderudit/geocan12_2fea02)

[Aller au sommaire du numéro](#)

Éditeur(s)

The Geological Association of Canada

ISSN

0315-0941 (imprimé)

1911-4850 (numérique)

[Découvrir la revue](#)

Citer cet article

Strong, D. F. & Longerich, H. P. (1985). Machinations:: The Inductively Coupled Plasma/Mass Spectrometer (ICP/MS). *Geoscience Canada*, 12(2), 72–75.

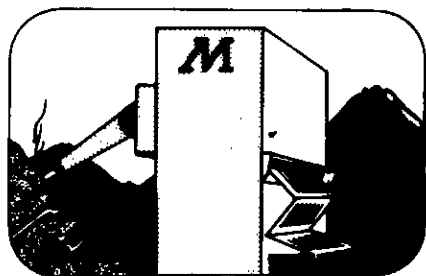

## Machinations

### The Inductively Coupled Plasma/Mass Spectrometer (ICP/MS)

D.F. Strong and H.P. Longrich  
 Department of Earth Sciences  
 Memorial University of Newfoundland  
 St. John's, Newfoundland A1B 3X5

#### Introduction

The recent marriage of the mass spectrometer to the inductively coupled plasma torch has provided a breakthrough in methods of elemental and isotopic analysis. This will have profound implications in all fields of inorganic analysis, especially geochemistry. ICP/MS instruments have only recently become commercially available, and are in geochemical use by only a few earth science organizations in Canada. This paper provides a brief review of the instrument and its operating principles, outlines some of its potential applications in geochemical studies, and provides several examples of whole-rock spectra and lead isotope ratios determined during its first month of operation in the Department of Earth Sciences at Memorial University of Newfoundland (MUN).

The analytical methods used in routine geochemical analysis have a number of drawbacks. X-ray fluorescence, for example, while being rapid and accurate for the major and many trace elements, is constrained by detection limits in the ppm range, and is not suitable for the lighter elements, such as Li, Be and B. Neutron activation is slow due to long irradiation, cooling and counting times, and suffers from critical interferences for a number of geochemically important elements. Atomic absorption spectrometry is hindered by a lack of simultaneous multi-element capability and requires complex preparation procedures for many elements, especially at low concentration levels. The ICP/MS system, with detection limits approaching one picogram/mL ( $10^{-12}$ g/mL) with good selec-

tivity for many elements, will be an invaluable addition to the geochemical analytical laboratory.

#### Principles of the ICP/MS

Reviews of the ICP/MS method are provided by Date and Gray (1983a, b); Gray and Date, (1983); Douglas *et al.* (1983), from which most of the following is taken. The use of ICP in chemical analysis is based on the principle that when a nebulized solution is sprayed into a plasma, the dissolved solids are vaporized, dissociated and most elements are highly ionized. These ionized atoms are then separated according to mass by the mass spectrometer, converted to electrical pulses by a channel electron multiplier detector (CEM), and counted by simple digital electronics.

*The Mass Spectrometer.* The mass spectrometer (MS) separates ions on the basis of their mass/charge ratios. The quadrupole MS is a rugged, fast scanning, moderate resolution, relatively inexpensive mass selector with a history of 40 years usage (Maugh, 1983; Todd *et al.*, 1976).

The quadrupole mass spectrometer contains four metal rods which are arranged to form a lengthwise passageway along which ions pass from a source (the ICP) to a detector (Fig. 1). Opposite rods are electrically connected, and an electric field which is a combination of direct current (dc) and radio frequency alternating current (rf) is applied. This electric field causes the ions to move in a complex oscillatory trajectory. The result is that ions of the selected mass pass through the channel and reach the CEM detector, while others do not. Different masses are selected by changing the dc and rf potentials. Very rapid scan speeds (1000 atomic mass units/sec) can be obtained on the quadrupole mass spectrometer (Lawson and Todd, 1972), and this contributes significantly to the speed of the ICP/MS system.

*Inductively Coupled Plasma.* A plasma is defined as a state of matter which contains

ionized atoms and electrons. Gray (1975, 1976) pioneered research on the extraction of ions into a mass spectrometer from an atmospheric pressure plasma, but he had limited success because of inter-element and matrix effects due to the interface and the type of plasma used (Date and Gray, 1983a, b). In order to eliminate these problems, an inductively coupled plasma was used by Houk *et al.* (1980, 1981) and Gray and Date (1983). Recent research on the method has been dominated by two groups, one at the University of Surrey in cooperation with the U.K. Institute of Geological Sciences (Gray and Date, 1983), and the other in Canada at SCIEX Inc. in Thornhill, Ontario (e.g., Douglas *et al.*, 1983). Instruments are now commercially available from SCIEX and from the other group through VG Isotopes Ltd.

The SCIEX ELAN instrument (Fig. 2) was recently installed in the MUN Department of Earth Sciences, and the following description of it is based on that of Douglas (1983). The SCIEX inductively coupled plasma is produced from argon flowing at atmospheric pressure through a torch which consists of three concentric quartz tubes. The torch is wound with a water-cooled copper coil to which is applied about 1.2 KW of rf power, heating the argon to between 7,000 and 10,000 K and maintaining it in the plasma state. Solutions to be analysed are aspirated through a concentric nebulizer into a spray chamber which removes oversize droplets; the remaining fine droplets pass into the plasma where the contained elements are ionized. A sample of the plasma is admitted into the mass spectrometer vacuum chamber through a 1.1 mm diameter opening into a mechanically pumped region operating at about 250 Pa (2 torr), and then through a second 0.9 mm diameter opening to a region operating at  $2.5 \times 10^{-3}$  Pa ( $2 \times 10^{-5}$  torr) (Fig. 2). This region, which contains the quadrupole MS and detector, is pumped rapidly via a cryogenic pump operating at 15K, aided by a charcoal absorber to

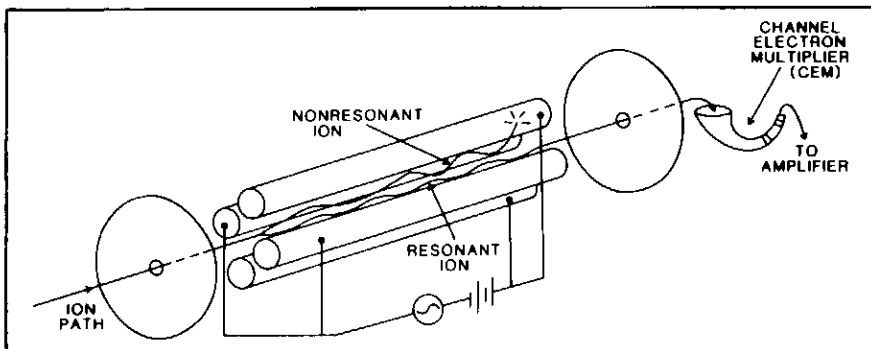

Figure 1 Schematic drawing of the quadrupole mass spectrometer and detector, with the alternating current radio frequency and direct current supplies shown as connected to the quadrupole rods (after Ewing, 1969)

remove non-condensing hydrogen and helium. A system of ion lenses in the vacuum chamber transmits the ions to the quadrupole mass filter for analysis, while decreasing the number of detectable photons reaching the detector.

**Some Uses of the ICP/MS**

Because most of the periodic table might be determined by the ICP/MS, at lower concentrations with greater speed than by traditional analytical methods, it has the potential of enhancing or surpassing any geochemical studies which are currently possible by other techniques. It must be noted that the analytical achievements to date have required little or no chemical pre-separation or pre-concentration, and research devoted to sample preparation, software and instrument set-up will undoubtedly produce even better results. Such advantages already make possible an entirely new array of studies which are not realistically possible without the ICP/MS, especially in the sub-ppm range of metal concentrations.

**Trace Element Studies.** To take the most fundamental example of trace element studies, hypotheses to explain many geochemical processes, such as mass transport, metal enrichment and depletion, are based on comparisons with crustal and lithological averages. Yet, such averages are derived from very few data, especially regarding the many elements which are present in extremely low concentrations, such as Au, Ag, platinum group elements, Sn, W, etc. With the ICP/MS, the very low detection limits now possible for such elements, the absence of significant inter-element interferences and the great speed of analysis will certainly provide a significant new body of such data, which is bound to change our view of element distributions.

The elements B, Be, Li, Sn, W, U, Nb, Ta and rare earths (REE) are most important in the study of granite-related mineral deposits because some are valuable and form ore deposits (e.g., Sn, W, U, Nb, Ta, REE); some exercise a critical influence on the behaviour of silicate melts and mineralizing fluids (e.g., B, Li); and others may act as tracers or indicators of mineralization (e.g., Li) and hence aid in mineral exploration (reviewed by Strong, 1980). Consequently, these are elements for which there is a critical need for good data on concentrations in both the granitoids and in their associated intrusive, volcanic and country rocks. Without the ICP/MS, these are also among the elements which are the most difficult to analyse because of their typically low concentrations in most rocks.

Figures 3 to 6 present ICP/MS spectra showing a separation of the peaks for such elements without overlap, demonstrating

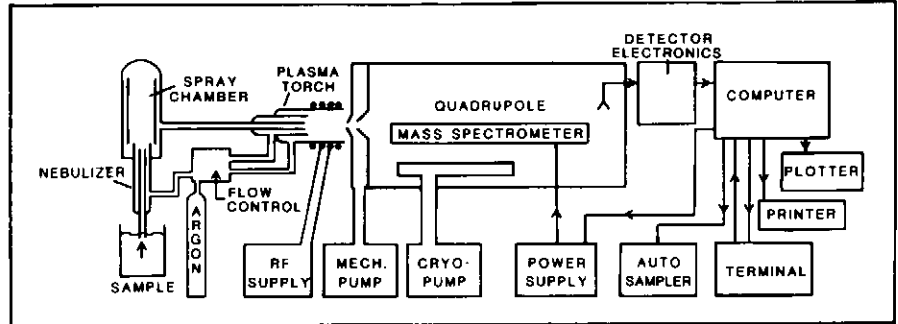

**Figure 2** Schematic drawing of the SCIEX ELAN model ICP/MS, modified from Douglas et al. (1983)

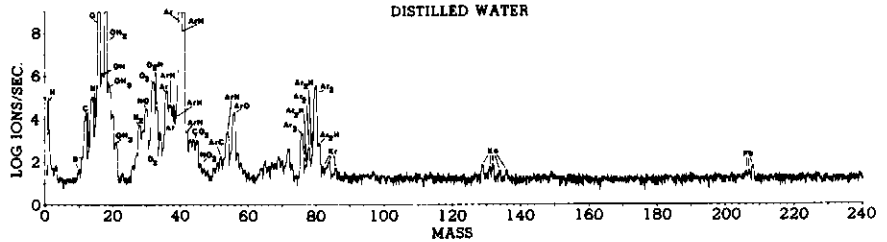

**Figure 3** ICP/MS spectrum of distilled water (background). The major species which are known well as some molecular ions of these elements. Note the Kr and Xe from the bottle gas, as well as B and Pb which are impurities in the water

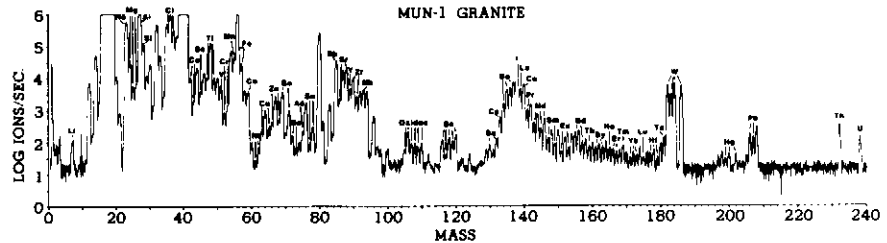

**Figure 4** Spectrum (not corrected for background) of a solution of one g/L of MUN-1, an in-house granite standard, in 0.2 M nitric acid following an open-beaker acid dissolution. The W is contaminant from the tungsten-carbide grinding equipment, and Sn from the hydrochloric acid. The oxide species are not identified, but easily noted are those for Sr, Y, Zr and Nb, as well as those for Ba, La, Ce, etc., which cause the intensity hump in the middle of the rare earth spectrum. These oxide species will have to be eliminated by chemical pre-separation, reduced by changes in instrumental operating conditions, or corrected for as an inter-element interference, before the rare earth elements heavier than Sm can be quantitatively determined.

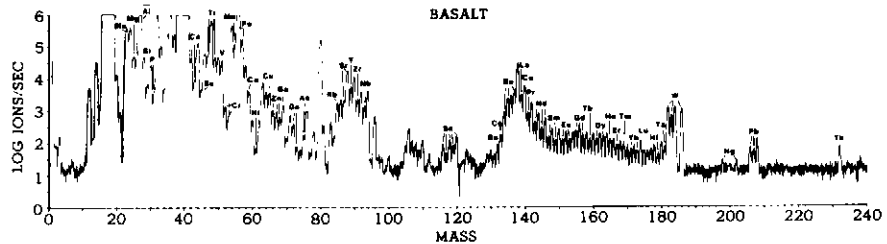

**Figure 5** Spectrum of a one g/L solution of basalt (sample no. RS-80). Prepared in the same way as MUN-1.

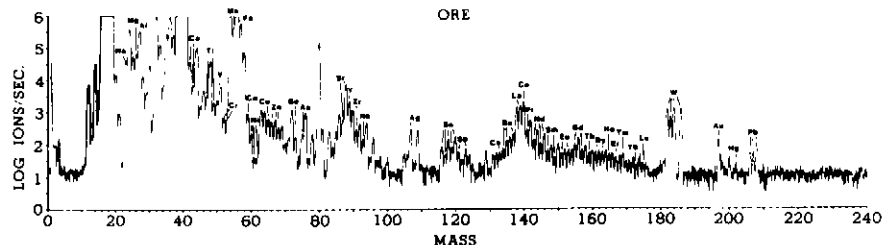

**Figure 6** Spectrum of gold ore sample (Agnico-Eagle, Quebec, sample no. AE37A). Note the higher peaks for Au and Ag (11 ppm) for this sample, despite low concentrations in the ore, although this solution was prepared in the same way as the other two, with no separation or other special techniques used

that they may be determined by this technique. Inspection of these spectra shows, for example, that Li, Nb, Th and U are higher in the "MUN-1" granite than either the basalt or ore sample, although these are "whole-rock" data on samples without any concentration or separation techniques, and there has been no attempt to standardize or quantify these spectra. It should be kept in mind that the scale on these peaks is logarithmic, so that the apparently subtle differences in the major elements, such as Na, are in fact in the correct proportions.

In other types of mineral deposits, such as volcanogenic massive sulphides, gold veins, etc., similar problems of low concentration are encountered, especially for elements such as Au, Ag, Sb, Cd, which may be both economically important in the ores, and geochemically important in the host volcanic rocks. A comparison of the Agnico-Eagle ore spectrum (Fig. 6) with those for granite or basalt (Figs. 4 and 5) clearly shows its higher concentrations of Au, Ag and Hg. It also shows other important features, e.g., although the total rare earths are lower in the ore, the relative concentrations of Ce and La are clearly different. Such features are of immediate genetic and exploration importance, considering the increasing use of rare earths in the study of ore deposits (Taylor and Fryer, 1984; Chatterjee and Strong, 1983).

**Lead Isotopes.** The possibility of performing isotopic analyses on a rapid routine basis will provide a statistical basis for such studies, which are now typically based on only a few analyses because of the cost and time for analysis. Such a study with the ICP/MS has already been carried out for Archean gold and base metal deposits by Smith *et al.* (1984) who, using a total analysis time of only ten minutes per

sample, produced lead isotope data in good agreement with known values determined by other methods. They also obtained trace element data for the galenas during the same analyses, which greatly enhanced their ability to "fingerprint" a range of gold and base metal deposits.

We have conducted a similar study on three galena samples with known Pb isotope ratios, namely, from the Buchans and Sullivan massive sulphide deposits and from an occurrence in Labrador. Each solution was prepared from a one g sample dissolved in HCl-HNO<sub>3</sub> and diluted to give 10 µg/mL in 0.2 M HNO<sub>3</sub>, and the isotope ratios are given in Table I. The uncertainties are standard deviations of the means of 100 repeat determinations in a total analysis time of ten minutes per sample, including time to measure Hg at mass 202 to correct for isotopic overlap of Hg at 204. Separate water blanks were subtracted. The mean relative standard deviation of all nine ratios is 0.34%, and a clear discrimination between different sources of Pb in the samples is apparent in Table I.

During measurement, all intensities are ratioed to 208, the most abundant isotope, in order to reduce the error in the ratios. Inspection of the differences between the measured ratios and the known values, divided by the mass differences of the two isotopes used in the ratios, indicates an average bias which enhances the lighter isotope by 4.17% per mass unit. Using this average as a correction, all ratios are recalculated and listed in Table I, showing excellent agreement with the known values.

Clearly, fast and accurate results are readily available with the ICP/MS. Measured values can be automatically corrected relative to international standards in much the same way that data-reduction is carried out for gas-source instruments measuring C, N and O isotope ratios. Although this

correction is mathematically comparable to that used in mass fractionation corrections applied to thermal ionization isotope ratios, for the ICP/MS the correction is a function of instrument set-up, not a function of the measurement time. It is, consequently, significantly more rapid.

### Summary

The following is a summary of the main characteristics of the ICP/MS which will make it so attractive for geochemical research. It is based on the review by Douglas *et al.* (1983) and our own observations to date:

1. Good selectivity for most elements from hydrogen to uranium is obtained. Since the detector is a mass spectrometer, intensities are measured as a function of mass, a quantized variable taking on integer values (1 to 238) and a few half integer values from species of odd atomic mass with a plus two charge. No plus three charged species have been observed, and are not expected, since there is no element in which the sum of first, second and third ionization potentials is less than the first ionization potential of argon.
2. Background signals of our instrument are from 5 to 15 apparent ions per second across the entire mass range (see Fig. 3). This is attributed to photons emitted from various excited species inside the mass spectrometer.
3. Spectral interferences from the plasma argon, the sample water and acid, as well as carbon and nitrogen, are apparent (see Fig. 3). The atomic species H<sup>+</sup>, C<sup>+</sup>, N<sup>+</sup>, O<sup>+</sup>, Ar<sup>+</sup>, as well as molecular ions formed from these atoms, are observed on our instrument, including for example OH<sup>+</sup>, H<sub>2</sub>O<sup>+</sup>, H<sub>3</sub>O<sup>+</sup>, ArH<sup>+</sup>, Ar<sub>2</sub><sup>+</sup>, Ar<sub>2</sub>H<sup>+</sup>, CO<sub>2</sub><sup>+</sup>, NO<sup>+</sup>, NO<sub>2</sub><sup>+</sup>, ArC<sup>+</sup>, ArN<sup>+</sup>, ArO<sup>+</sup> and ArOH<sup>+</sup>. However, except for Kr and Xe, which our experiments indicate are impurities in the

**Table I** Lead isotope ratios of galena samples measured by the MUN ICP/MS, compared to known values

	207/208			206/208			204/208			Mean
	Lab.	Sull.	Buch.	Lab.	Sull.	Buch.	Lab.	Sull.	Buch.	
Measured	.4522	.4473	.4305	.4547	.4932	.5143	.0337	.0321	.0311	
$\sigma$	.0017	.0016	.0012	.0016	.0019	.0018	.0001	.0001	.0001	
Relative $\sigma$	.36	.36	.28	.35	.39	.35	.30	.31	.32	.34
Known value	.4341	.4278	.4121	.4225	.4568	.4738	.0291	.0276	.0266	
Meas.-Known	.0181	.0195	.0184	.0322	.0364	.0405	.0046	.0045	.0045	
Rel. Diff.	.0417	.0456	.0446	.0762	.0797	.0855	.1581	.1630	.1692	
$\Delta$	1	1	1	2	2	2	4	4	4	
Rel. Diff./ $\Delta$	.0417	.0456	.0446	.0381	.0398	.0428	.0395	.0408	.0423	.0417
$\beta = 1 + 0.0417 \Delta$	1.0417	1.0417	1.0417	1.0834	1.0834	1.0834	1.1668	1.1668	1.1668	
Corr. = Meas./ $\beta$	.4341	.4294	.4133	.4197	.4552	.4747	.0289	.0275	.0267	
Corr.-Known	.0000	.0016	.0012	-.0028	-.0016	.0009	-.0002	-.0001	.0001	
(Corr.-Known)/ $\sigma$	0.0	1.0	.4	1.8	.8	.5	2.0	-1.0	1.0	

Lab. = Labrador galena, "known" value from Dr. D. Wilton (pers. comm.); Sull. = galena from Sullivan mine, British Columbia, with "known" value from Andrew *et al.* (1984); Buch. = galena from Buchans mine, Newfoundland, with "known" value from Bell and Blenkinsop (1981).  $\sigma$  = standard deviation of the mean.  $\Delta$  = mass difference.  $\beta$  = mass discrimination correction.

cylinder of compressed argon gas, there are NO plasma or solvent species of mass greater than 81 ( $^{40}\text{Ar}_2\text{H}$ ). This is especially fortunate, as the less abundant, heavier elements are found in this low background region. We note also that there are low background regions between 6 and 11 for Li, Be, B and at mass numbers 23-27 (Na, Mg, Al). Nevertheless, most other major elements lighter than Kr may still be analysed, but with higher detection limits and higher errors. Elements such as Th and Ce which form stable oxides exhibit spectra from the metal, metal oxide and metal hydroxide. Initially, we have seen a worst case of 10% oxide, but we have been advised by the manufacturer that with optimization there should be no more than one per cent. The background spectra (Fig. 3) also show B and Pb contamination derived respectively from boro-silicate glass in the water still, and the ubiquitous tetra-ethyl lead from automotive exhaust.

4. Detection limits are improving rapidly. For example, in January, 1984 limits of 3 pg/mL were being reported, compared to one ng/mL a year earlier. Preliminary measurements on our instrument prior to optimization have yielded a 10 pg/mL limit of detection ( $3\sigma$ ). Figure 7 shows a 30 pg/mL Sr solution clearly differentiated from the background. This is not the ultimate limit, since a solution of one pg/mL with an atomic mass of 100, flowing at one mL/min provides about 100 million ions/sec., of which only 2 or 3 ions/sec. reach the detector.

5. Other methods of sample introduction which have been developed for plasma-optical emission and atomic absorption, such as hydride generation, electrothermal

atomization, laser ablation and direct insertion into the plasma, will reduce the interferences as well as result in greatly increased sensitivity and lower detection limits.

6. Isotope ratio determinations are possible, with routine determination at the 0.1 to 1.0% precision level with a measurement time of about five to ten minutes per sample at element concentration ranges up to one  $\mu\text{g/mL}$ . Although this precision will not compete with thermal ionization mass spectrometry, it is considerably faster and allows for determinations of isotope ratios of most multi-isotopic elements without time-varying mass fractionation corrections (up to 0.5% per mass unit) observed in thermal ionization instruments.

7. Elemental analysis can be performed rapidly over a high practical dynamic range of 6 orders of magnitude, potentially allowing simultaneous determination of major through trace levels of elements without dilution or changing samples. High precision and accuracy can be guaranteed by using the isotope dilution method, which could better be described as an isotopic internal standard method.

#### Acknowledgements

We are grateful to Drs. B.J. Fryer and D.H. Wilton for donation of samples and criticism of the manuscript, and Judy Lappi for sample preparation. The SCIEX ELAN ICP/MS instrument was purchased through NSERC Major Installation Grant SMI-90, and is operated with the financial assistance of NSERC Operating Grant A7975 and Infrastructure Grant A8876, and generous support from Memorial University of Newfoundland.

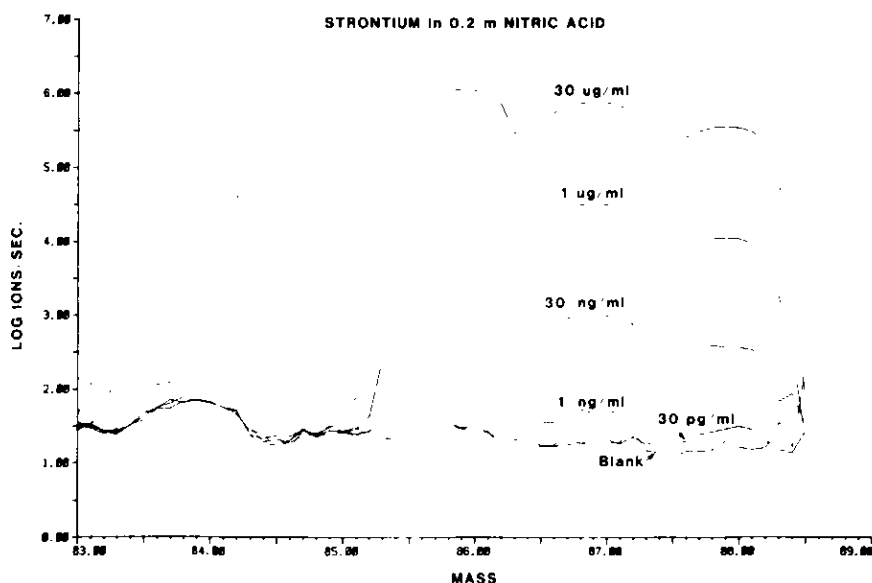

**Figure 7** ICP MS spectra for five strontium solutions and a blank over six orders of dynamic range. Note the clear separation of 30 pg/mL from the background. The interference due to Kr at 84 is readily apparent as well as a smaller background at 86 from a less abundant Kr isotope

#### References

- Andrew, A., C.I. Godwin, A.J. Sinclair, 1984, Mixing line isochrons: a new interpretation of galena lead isotope data from southeastern British Columbia: *Economic Geology*, v. 79, p. 919-932.
- Bell, K. and J. Blenkinsop, 1981, A geochronological study of the Buchans area, Newfoundland: *Geological Association of Canada, Special Paper 22*, p. 91-112.
- Chatterjee, A.K. and D.F. Strong, 1984, Rare earth and other element variations in greisens and granites associated with the East Kemptville tin deposit, Nova Scotia, Canada: *Institution of Mining and Metallurgy, Transactions, Section B*, v. 93, p. B59-B70.
- Date, A.R. and A.L. Gray, 1983, Progress in plasma source mass spectrometry: *Spectrochimica Acta*, v. 38B, p. 29-37.
- Date, A.R. and A.L. Gray, 1983, Development progress in plasma source mass spectrometry: *The Analyst*, v. 108, p. 159-165.
- Douglas, D.J., 1983, Elemental analysis with an atmospheric pressure plasma (MIP, ICP)/quadrupole mass spectrometer system: *Spectrochimica Acta*, v. 38B, p. 39-48.
- Douglas, D., G. Rosenblatt and E. Quan, 1983, Inductively coupled plasma/mass spectrometry – a new technique for trace element and isotope analysis: *Quarterly Journal of Plasma Spectroscopy*, v. 3, p. 140-149.
- Ewing, G.W., 1969, *Instrumental Methods of Chemical Analysis*, 3rd edition: McGraw Hill, p. 391.
- Gray, A.L., 1975, Mass-spectrometric analysis of solutions using an atmospheric pressure ion source: *The Analyst*, v. 100, p. 289-299.
- Gray, A.L., 1976, Trace analysis of solutions using an atmospheric pressure ion source. *Dynamic Mass Spectrometry*, v. 4, Heyden, London, p. 153-162.
- Gray, A.L. and A.R. Date, 1983, Inductively coupled plasma source mass spectrometry using continuum flow ion extraction: *The Analyst*, v. 108, p. 1033-1050.
- Houk, R.S., V.A. Fassel, G.D. Flesch, H.J. Svec, A.L. Gray, and C.E. Taylor, 1980, Inductively coupled argon plasma as ion source for mass spectrometric determinations of trace elements: *Analytical Chemistry*, v. 52, p. 2283-2289.
- Houk, R.S., V.A. Fassel and H.J. Svec, 1981, ICP/MS sample introduction, ionization, ion extraction, analytical results: *Dynamic Mass Spectrometry*, v. 6, p. 234-251.
- Maugh, T.H., 1983, Quadrupoles appear in new instruments: *Science*, v. 220, p. 178-179.
- Smith, R.G., E.J. Brooker, D.J. Douglas, E.S.K. Quan and G. Rosenblatt, 1984, The typing of gold and base metal occurrences by plasma/mass spectrometry: *Journal of Geochemical Exploration*, v. 21, p. 385-393.
- Strong, D.F., 1980, Granitoid rocks and associated mineral deposits of eastern Canada and western Europe: *Geological Association of Canada, Special Paper 20*, p. 741-769.
- Taylor, R.P. and B.J. Fryer, 1983, Rare earth element lithogeochemistry of granitoid mineral deposits: *Canadian Institute of Mining and Metallurgy Bulletin*, v. 76, p. 74-84.
- Todd, T.J.F., G. Lawson and R.F. Bonner, 1976, *Quadrupole Mass Spectrometry and Its Applications*, P.H. Dawson, ed., Elsevier, Amsterdam, 181 p.

Ms received March 8, 1985