

AOC reduction by biologically active filtration Réduction du carbone organique assimilable par filtration biologiquement activée.

M. W. Lechevallier, W. C. Becker, P. Schorr et R. G. Lee

Volume 5, numéro hors-série, 1992

URI : <https://id.erudit.org/iderudit/705156ar>

DOI : <https://doi.org/10.7202/705156ar>

[Aller au sommaire du numéro](#)

Éditeur(s)

Université du Québec - INRS-Eau, Terre et Environnement (INRS-ETE)

ISSN

0992-7158 (imprimé)

1718-8598 (numérique)

[Découvrir la revue](#)

Citer cet article

Lechevallier, M. W., Becker, W. C., Schorr, P. & Lee, R. G. (1992). AOC reduction by biologically active filtration. *Revue des sciences de l'eau / Journal of Water Science*, 5, 113–142. <https://doi.org/10.7202/705156ar>

Résumé de l'article

L'objectif de ce projet était de fournir un guide pratique de l'application des techniques de traitement biologique aux opérations de traitement actuel des eaux. Les études furent centrées sur la production d'une eau biologiquement équilibrée, sur la stabilité (l'équilibre) des désinfectants, et sur la formation moins importante de sous-produits désinfectants. Notamment, l'étude a montré que les processus biologiques peuvent satisfaire les besoins de la pratique aussi bien que les exigences réglementaires de l'industrie de l'eau.

Le système de surveillance et de contrôle des niveaux du carbone organique assimilable (COA) des effluents de la "Swimming River Treatment Plant" a montré que des données >100 µg/L pourraient expliquer d'une part, l'apparition des bactéries conformes dans le système de distribution et d'autre part la transgression potentielle des règlements récemment révisés de la "Limite Maximum de Contaminants de Coliformes" des États-Unis. L'optimum du traitement a été établi à <100 µg/L pour les méthodes de traitement biologiquement activées.

Des études évaluant des genres de filtres différents ont démontré que des filtres de carbone granuleux actif (CGA) peuvent supporter une population bactérielle plus grande, et ainsi, permettre une meilleure suppression biologique du COA et du carbone organique total (COT). Les filtres de carbone granuleux actif peuvent rester biologiquement actifs même à une basse température d'eau (<5 °C). Des filtres à lit profond de COA étaient un peu plus efficaces que les filtres constitués de COA et de sable pour la suppression du COA et du COT. Toutefois, le meilleur résultat fut attribué à l'expérience mettant en oeuvre une plus grande période de temps de résidence en lit vide (TRLV). Tous les filtres biologiquement actifs ont démontré une bonne performance liée au niveau de turbidité de l'effluent, à la suppression des parasites et à la diminution de la vitesse de l'écoulement de l'eau. Les résultats indiquent que les filtres biologiquement actifs devraient satisfaire les règlements de turbidité du Code de Traitement des Eaux de Surface (CTES) des États-Unis avec des longueurs de filtres appropriées.

Un pré-traitement à l'ozone de l'eau crue a augmenté le niveau du COA d'une moyenne de 2,3 fois et a intensifié le niveau du COA de l'effluent par rapport à l'eau non-pré-traitée à l'ozone. Parce que le CAG peut neutraliser rapidement le chlore libre, l'emploi de chlore libre aux filtres de CAG n'a pas empêché l'activité biologique. Les résultats obtenus indiquent que beaucoup de filtres conventionnels peuvent déjà achever une bonne suppression du COA. L'utilisation des chloramines aux filtres CAG a indiqué une légère activité inhibitrice en proportion de la teneur en chlore libre. La stabilité des résidus de chloramine permet au désinfectant de pénétrer le filtre et de maintenir des traces résiduelles dans l'effluent provenant du filtre. Les niveaux bactériels hétérotrophes (HPC) dans les filtres pré-chloraminés étaient dix fois moindres que dans les filtres pré-chlorés ou pré-ozoneés. TRLV n'avait qu'un effet réduit sur l'enlèvement du COA. Les niveaux de l'effluent du COA draient en moyenne de 82 µg/L à un TRLV de cinq minutes, et avaient diminués à une moyenne de 57 µg/L à un TRLV de vingt minutes. Il n'est pas sûr que l'injection d'azote ou de phosphore dans les filtres pourrait permettre la suppression du COA. Le TRLV avait un effet sur l'élimination du COT, avec des rendements respectifs en moyennes de 29, 33, 42 et 51 % d'élimination pour des TRLVs de 5, 10, 15 et 20 minutes.

La formation potentielle de méthane tri-halogéné (FPMI) est liée à la teneur en COT. Les processus qui réduisent la teneur en COT font aussi décroître le FPMTH. Un filtre de GAG/sable pré-ozoneé (TRIV 10 min.) permettait une suppression moyenne annuelle de 54 % des éléments précurseurs de FPMTH. Les taux de FPMTH dans le filtre effluent avait une moyenne de 99 µg/L (107 µg/L après les 60 premiers jours). En comparaison, les taux de FPMTH dans le SRTP étaient presque le double (178 µg/L). Une désinfection postérieure des effluents traités biologiquement a réduit la flore bactérielle hétérotrophe d'un \log_{10} de 2 à 2,5. Le chlore libre (1 mg/L) a produit de meilleurs taux d'inactivité que les chloramines (2 mg/L) pré-formées dans un intervalle de 30 minutes. Un traitement postérieur au chlore ou à la chloramine des effluents pré-chlorés d'un filtre CAG/sable a eu pour résultat une augmentation respective des niveaux de COA de 20 %, et de 44 %.

Une désinfection postérieure de l'eau pré-ozoneée a pour résultat une faible (<8 %) augmentation de COA. Malgré les augmentations de la teneur en COA, l'eau pré-chlorée a des teneurs en COA plus faible que l'eau pré-ozoneée, même après une désinfection postérieure.

La conclusion du rapport est que les absorbants des filtres de CAG/sable biologiquement actifs peuvent produire des effluents d'une teneur en COA de <100 µg/L, d'une turbidité basse, avec des FPMTH réduite durant une période de traitement acceptable. Ce processus peut être facilement appliqué aux systèmes actuels de traitement des eaux. Un traitement biologique est présenté en tant que procédé pour satisfaire les demandes rigoureuses du traitement des eaux.

AOC reduction by biologically active filtration

Réduction du carbone organique assimilable par filtration biologiquement activée

M.W. LECHEVALLIER^{1**}, W.C. BECKER², P. SCHORR³, R.G. LEE²

Reçu le 12 novembre 1991, accepté pour publication le 24 juillet 1992*.

SUMMARY

Biological treatment was examined for production of biologically stable water, increase disinfectant stability, and reduced formation of disinfection by-products. Monitoring of assimilable organic carbon (AOC) levels in the effluent of the Swimming River Treatment Plant (SRTP) showed that values >100 ug/L could be related to the occurrence of coliform bacteria in the distribution system. A treatment goal of <100 ug/L was established for biologically active treatment processes. Granular activated carbon (GAC) filters were found to support a larger bacterial population, and thus, provide better biological removal of AOC and total organic carbon (TOC). All biologically active filters showed good performance relative to effluent turbidity levels, and headloss development. Preozonation of raw water increased AOC levels an average of 2.3 fold, and always increased filter effluent AOC levels relative to nonozonated water. Application of free chlorine to GAC filters did not inhibit biological activity. Application of chloramines to GAC filters showed a slight inhibitory effect relative to free chlorine. Effluent AOC levels averaged 82 ug/L at an EBCT of 5 min, and decreased to an average of 57 ug/L at 20 min EBCT. EBCT did affect TOC removals, with efficiencies averaging 29, 33, 42, and

Key-words : *assimilable organic carbon, total organic carbon, biological filtration, potable water treatment, granular active carbon, filtration, disinfection, ozone, chlorine, chloramine, bacterial regrowth.*

1. American Water Works Service Co., Inc., Belleville Laboratory, 1115 S. Illinois St., Belleville, IL 62220, USA.
2. American Water Works Service Co., Inc., 1025 Laurel Oak Rd., Voorhees, NJ 08043, USA.
3. New Jersey Department of Environmental Protection, Safe Drinking Water, CN 029, Trenton, NJ 08625-0029, USA.

* Les commentaires seront reçus jusqu'au 30 juin 1993.

** Corresponding author.

This article was adapted from "Evaluating the Performance of Biologically Active Rapid Filters", Journal AWWA, Vol. 84, n° 4 (April 1992). Used with Permission.

51 % removal at EBCTs of 5, 10, 15 and 20 min, respectively. Trihalomethane formation potentials (THMFP) were related to TOC levels. Processes that decreased TOC levels also decreased THMFP. A preozonated GAC/sand filter (EBCT 10 min) achieved an annual average 54 % removal of THMFP precursors. Post disinfection of biologically treated effluents reduced HPC bacterial counts by 2-2.5log₁₀. Post chlorination or chloramination of prechlorinated GAC/sand effluents resulted in a 20 %, or a 44 % (respectively) increase in AOC levels. Post disinfection of preozonated water resulted in small (< 8 %) AOC increases. Despite increases in AOC levels, prechlorinated water had lower AOC levels than preozonated water, even after post disinfection.

RÉSUMÉ

L'objectif de ce projet était de fournir un guide pratique de l'application des techniques de traitement biologique aux opérations de traitement actuel des eaux. Les études furent centrées sur la production d'une eau biologiquement équilibrée, sur la stabilité (l'équilibre) des désinfectants, et sur la formation moins importante de sous-produits désinfectants. Notamment, l'étude a montré que les procédés biologiques peuvent satisfaire les besoins de la pratique aussi bien que les exigences réglementaires de l'industrie de l'eau.

Le système de surveillance et de contrôle des niveaux du carbone organique assimilable (COA) des effluents de la "Swimming River Treatment Plant" a montré que des données >100 µg/L pourraient expliquer d'une part, l'apparition des bactéries coliformes dans le système de distribution et d'autre part la transgression potentielle des règlements récemment révisés de la "Limite Maximum de Contaminants de Coliformes" des Etats-Unis. L'optimum du traitement a été établi à <100 µg/L pour les méthodes de traitement biologiquement activé.

Des études évaluant des genres de filtres différents ont démontré que des filtres de carbone granuleux actif (CGA) peuvent supporter une population bactérielle plus grande, et ainsi, permettre une meilleure suppression biologique du COA et du carbone organique total (COT). Les filtres de carbone granuleux actif peuvent rester biologiquement actifs même à une basse température d'eau (< 5 °C). Des filtres à lit profond de COA étaient un peu plus efficaces que les filtres constitués de COA et de sable pour la suppression du COA et du COT. Toutefois, le meilleur résultat fut attribué à l'expérience mettant en œuvre une plus grande période de temps de résidence en lit vide (TRLV). Tous les filtres biologiquement actifs ont démontré une bonne performance liée au niveau de turbidité de l'effluent, à la suppression des parasites et à la diminution de la vitesse de l'écoulement de l'eau. Les résultats indiquent que les filtres biologiquement actifs devraient satisfaire les règlements de turbidité du Code de Traitement des Eaux de Surface (CTES) des États-Unis avec des longueurs de filtres appropriées.

Un pré-traitement à l'ozone de l'eau crue a augmenté le niveau du COA d'une moyenne de 2,3 fois et a intensifié le niveau du COA de l'effluent par rapport à l'eau non-pré-traitée à l'ozone. Parce que le CAG peut neutraliser rapidement le chlore libre, l'emploi de chlore libre aux filtres de CAG n'a pas empêché l'activité biologique. Les résultats obtenus indiquent que beaucoup de filtres conventionnels peuvent déjà achever une bonne suppression du COA. L'utilisation des chloramines aux filtres CAG a indiqué une légère activité inhibitrice en proportion de la teneur en chlore libre. La stabilité des résidus de chloramine permet au désinfectant de pénétrer le filtre et de maintenir des traces résiduelles dans l'effluent provenant du filtre. Les niveaux bactériels hétérotrophes (HPC) dans les filtres pré-chloraminés étaient dix fois moindres que

dans les filtres pré-chlorés ou pré-ozonés. TRLV n'avait qu'un effet réduit sur l'enlèvement du COA. Les niveaux de l'effluent du COA étaient en moyenne de 82 $\mu\text{g/L}$ à un TRLV de cinq minutes, et avaient diminué à une moyenne de 57 $\mu\text{g/L}$ à un TRLV de vingt minutes. Il n'est pas sûr que l'injection d'azote ou de phosphore dans les filtres pourrait permettre la suppression du COA. Le TRLV avait un effet sur l'élimination du COT, avec des rendements respectifs en moyennes de 29, 33, 42 et 51 % d'élimination pour des TRLVs de 5, 10, 15 et 20 minutes.

La formation potentielle de méthane tri-halogéné (FPMI est liée à la teneur en COT. Les processus qui réduisent la teneur en COT font aussi décroître le FPMTH. Un filtre de GAG/sable pré-ozoné (TRIV 10 min.) permettait une suppression moyenne annuelle de 54 % des éléments précurseurs de FPMTH. Les taux de FPMTH dans le filtre effluent avait une moyenne de 99 $\mu\text{g/L}$ (107, $\mu\text{g/L}$ après les 60 premiers jours). En comparaison, les taux de FPMTH dans le SRTP étaient presque le double (178 $\mu\text{g/L}$).

Une désinfection postérieure des effluents traités biologiquement a réduit la flore bactérielle hétérotrophe d'un \log_{10} de 2 à 2,5. Le chlore libre (1 mg/L) a produit de meilleurs taux d'inactivité que les chloramines (2 mg/L) pré-formées dans un intervalle de 30 minutes. Un traitement postérieur au chlore ou à la chloramine des effluents pré-chlorés d'un filtre CAG/sable a eu pour résultat une augmentation respective des niveaux de COA de 20 %, et de 44 %. Une désinfection postérieure de l'eau pré-ozonée a pour résultat une faible (< 8 %) augmentation de COA. Malgré les augmentations de la teneur en COA, l'eau pré-chlorée a des teneurs en COA plus faible que l'eau pré-ozonée, même après une désinfection postérieure.

La conclusion du rapport est que les absorbants des filtres de CAG/sable biologiquement actifs peuvent produire des effluents d'une teneur en COA de < 100 $\mu\text{g/L}$, d'une turbidité basse, avec des FPMTH réduite durant une période de traitement acceptable. Ce processus peut être facilement appliqué aux systèmes actuels de traitement des eaux. Un traitement biologique est présenté en tant que procédé pour satisfaire les demandes rigoureuses du traitement des eaux.

Mots clés : *carbone organique assimilable, carbone organique total, filtration biologique, traitement de l'eau potable, carbone actif granuleux, filtration, désinfection, ozone, chlore, chloramine (amine chloré), redéveloppement des bactéries.*

INTRODUCTION

In June of 1984, coliform bacteria were first isolated from the New Jersey American Water Company - Monmouth District (NJAWC), distribution system. Coliform bacteria have persisted at varying levels since that time. Extensive monitoring at the treatment plant has failed to recover significant levels of coliform bacteria. In addition to an already accelerated distribution system and treatment plant schedule, nearly 800 finished water samples were examined for injured coliforms using m-17 agar. Subsequent studies using weekly high volume (500 to 2,000 liter) samples did not detect particle associated coliforms in plant effluents. Examination of filter media from filter underdrains and

tubercles scraped from the clearwell similarly failed to recover coliform bacteria. Remedial actions to control the coliform episodes included increased chlorination (to 4.3 mg/L free chlorine), application of chlorine dioxide (pre-disinfectant), discontinuation of powdered activated carbon, application of zinc orthophosphate (instead of polyphosphate) for corrosion control, yearly systematic flushing of the distribution system, pH adjustment (from 7.0 to 9.0), improved coagulation and flocculation, improved sludge blanket operation with powdered activated carbon addition, cleaning of sedimentation basins, increased filter performance, improved filter backwashing and cleaning of filter media, and replacement of filter material.

Research initiated in 1986 indicated that coliforms in the distribution system were coming from pipeline biofilms (LECHEVALLIER *et al.* 1987). Results showed coliform levels increased as the water moved through from the treatment plant through the distribution system. Isolation of coliform bacteria from distribution system biofilms showed that these bacteria had the same biochemical (API 20e) profile as bacteria isolated from the water column. Assimilable organic carbon determinations (AOC by the Van Der Kooij method) showed carbon levels declined as the water moved through the study area. Calculations showed that sufficient carbon was utilized to support 8.0×10^4 bacteria/mL. This calculated value was close to actual HPC bacterial levels observed in dead end sections (average 8.5×10^4 bacterial/mL). The study concluded that coliform organisms were regrowing in the distribution system, and that no operational defects (treatment plant breakthrough, inadequate disinfectant residuals, cross contamination, etc.) could account for the coliform occurrences (LECHEVALLIER *et al.* 1987).

The relationship between bacterial regrowth and a variety of bacterial nutrients (TOC, AOC, nitrate, nitrite, ammonia, ortho and total phosphate) was examined in the NJAWC system (LECHEVALLIER *et al.*, 1990, 1991). The research found that only AOC values declined as the water moved through the distribution pipelines. Statistical analysis showed that no single parameter was able to accurately predict episodes of coliform growth. However, development of multiple linear regression models have demonstrated that nutritional (organic carbon and nitrogen) and physical parameters (rainfall, temperature) could be related to coliform occurrences in distribution water. Available evidence suggested that rainfall events washed nutrients into the water supplies which promoted growth of coliform bacteria in the distribution system. The time lag between rainfall events and coliform growth was 4-7 days.

Research in which water samples were spiked with various nutrients (carbon, nitrogen or phosphorous) showed that carbon and nitrogen were important growth-limiting compounds for coliform bacteria (LECHEVALLIER *et al.*, 1990). These findings support the statistical observations of the multiple regression model.

The investigation of biological treatment was initiated as part of a plan to limit bacterial growth in distribution system biofilms. The goal the project included production of biologically stable water, increased disinfectant stability, and reduced formation of disinfection by-products. Specific experiments examined different filter media, various preoxidants, empty bed contact time, and reduction of THM precursors. Importantly, experiments examined perfor-

mance characteristics of microbially active filters to determine if biological processes can meet the practical as well as regulatory requirements of the water industry. The project also characterized the conditions which promote coliform regrowth in distribution water.

MATERIALS AND METHODS

Pilot plant

The pilot plant was located at the New Jersey American Water Company – Swimming River Treatment Plant (SRTP). A diagram of the pilot plant is shown in figure 1. The plant had the capacity to draw water directly from the Swimming River Reservoir or from the SRTP's mixed water (alum, powdered activated carbon, chlorine). The mixed water was only used during the start-up of the pilot plant and not during any of the experimental runs. The Swimming River Reservoir is a 2.65 billion gallon (1×10^{10} L) capacity on – stream reservoir fed by various brooks and streams covering a 48 square-mile (80 km²) watershed area. Raw water characteristics are shown in table 1.

Table 1 Summary of Raw Water Characteristics.

Tableau 1 Résumé des caractéristiques des eaux crues.

Time period	N	Turbidity (NTU)	Temperature °C	Alkalinity mg/L	Hardness mg/L	pH units
01/20/88 – 03/10/89	108	3.4	3.5	27.8	64.4	7.3
03/13/89 – 05/15/89	153	5.5	10.5	24.8	64.5	7.4
05/22/89 – 08/09/89	62	12.2	19.4	28.6	54.7	6.3
08/10/89 – 10/17/89	138	8.9	21.0	31.0	53.4	7.1
10/18/89 – 11/20/89	68	6.5	14.4	26.1	52.5	6.8
01/22/90 – 03/05/90	99	3.2	4.7	25.6	61.4	7.4
03/06/90 – 05/28/90	140	4.0	12.7	25.3	57.5	7.5
05/29/90 – 07/30/90	144	2.4	23.7	23.6	53.0	7.5
07/31/90 – 09/01/90	76	3.3	25.5	20.9	43.5	7.6

Raw water could bypass the ozone contactor, or be treated with ozone generated by a Griffin Model GTC-OIC ozone generator (Lodi, NJ). The ozone dose was determined by the iodometric method (AMERICAN PUBLIC HEALTH ASSOCIATION, 1985) using a wet test meter to accurately measure the volume of gas analyzed (BECKER *et al.* 1989). The ozone gas was delivered through stainless steel pipes to a 6" (15.3 cm) ceramic diffuser in a two section 12' x 7.5" diameter (5.48 m x 19 cm) plexiglass contact chamber. At a flow rate of 2.5 gal/min (9.5 L/min), the contact time in the ozone chamber was approximately 10 min. The transfer efficiency of ozone (measured by determining the difference between the dose and the off-gas) was 94 %. Ozone residuals in

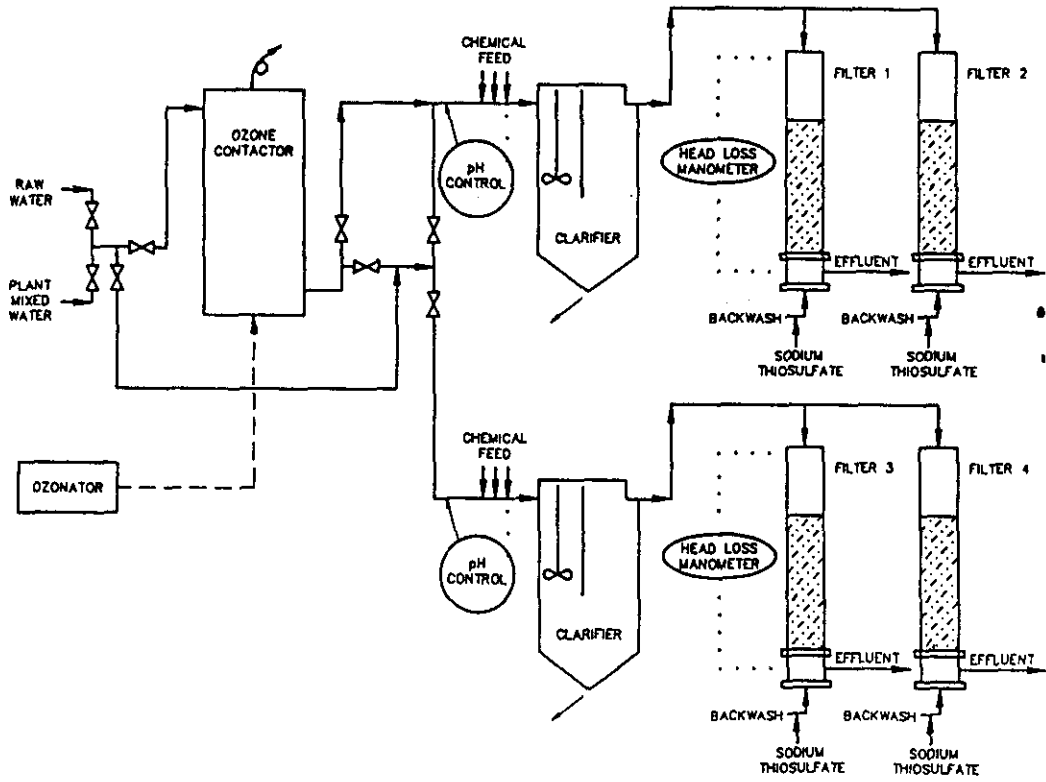

Figure 1

Schematic of the Pilot Plant.
Schéma de l'Usine-Pilote.

BIOLOGICAL TREATMENT STUDY
PILOT PLANT SCHEMATIC



the treated water were determined by the indigo method using the Hach DR-100 Colorimetric kit and low-range AccuVac ampules (Hach Chemical Company, Loveland, CO). Raw water that was not ozonated could be treated with free chlorine prepared from stock solutions of commercially available bleach. For trials in which the water was dechlorinated, sodium thiosulfate (1 mg/L final concentration) was added to the effluent of the sedimentation basin (prior to the filters). For trials which used chloraminated water, ammonium chloride was added to the effluent of the sedimentation basin at a ratio of 3:1 chlorine to ammonia.

Chlorine, alum, and cationic polymer were metered using Masterflex pumps. The pH of the water was maintained at 7.2 with caustic (sodium hydroxide) using a Hanna Instruments pH controller (Cole Parmer Instrument Co., Chicago, IL). Chemicals were mixed via a series of in-line 90° bends before the water entered one of two triangular shaped (8' [2.44 m] tall, 46" [117 cm] sides ; 2.93 h detention time at 2.5 gal/min [9.5 L/min]) sedimentation basins. In practice the sedimentation basins worked poorly, with little or no turbidity removal. Except for the additional contact time provided by the basins, the pilot plant operated essentially in a "direct filtration" mode.

From each sedimentation basin, the water flowed to two 72" (183 cm) tall, 6" (15.3 cm) internal diameter plexiglass filter columns. There was no observable impact of the plexiglass on the performance of the biologically active filters. Each filter was equipped with 3/4" inlet, outlet, waste and backwash connections with valves, and a strainer under-drain system with plenum. Filters contained either mixed media, GAC/sand, or deep-bed GAC filters as described in table 2. Fresh media was used for the three experiments which compared media configuration. All other experiments were performed with exhausted GAC.

Tableau 2 Pilot plant media configurations.

Table 2 Configurations des milieux d'Usine-Pilote.

Mixed media	GAG/sand	Deep Bed GAC	Gravel base
Anthracite 18"	GAC 20"	GAC 48"	Gravel 3/16 x #10 3"
Sand 9"	Sand 10"		Gravel 3/8 x 3/16 3"
Garnet 3"			Gravel 5/8 x 3/8 3"
			Gravel 1 1/2 x 3/4 4. 5"

Material	Uniformity coefficient	Specific gravity (g/cc)	Effective size (mm)
GAC*	< 1.9	1.3 - 1.4	0.8 - 0.9
Anthracite	< 1.8	1.5	1.0 - 1.2
Sand	< 2.0	2.4	0.35 - 0.50
Garnet	< 3.0	4.5	0.16 - 0.32

* Filtersorb 400.

Filters were backwashed daily (at 9 am) with dechlorinated tap water. Backwash occurred in three phases, a low rate wash (2.9 gal/ft² [36L/m²]) for 2 min, a high rate wash (12 gal/ft² [149L/m²]) for 10 min, followed by a repeat of the low rate wash. Weekly, the filters were air scoured to breakup mudballs.

The pilot plant was operated continuously Monday through Friday and was shut down over the weekends. It was attended by a researcher 8 h/day and observed periodically during the other 16 h by the SRTP operator. During the operating day samples of the raw water, ozonated water, clarified water and filter effluent were collected every two hours and analyzed for turbidity, temperature, pH, and oxidant residual. Flow rates, and headloss were recorded every two hours. Raw water and filter effluent alkalinity and hardness were recorded daily. All analyses were performed according to accepted procedures (14). Free and total chlorine residuals were determined by the *N,N*-diethyl-*p*-phenylenediamine (DPD) procedure. Turbidity was measured on a Hach Model 2100A turbidimeter. Rainfall measurements were recorded daily using a rain gauge at the treatment plant. To minimize the impact of the weekend shutdown and due to logistic reasons, microbiological and organic carbon analyses were performed on Wednesday through Friday after the plant had an opportunity to stabilize.

In addition to evaluating the performance of the pilot plant, chemical and physical determinations were performed on the Swimming River Plant effluent.

Analytical techniques

Microbiological Analyses

Samples for bacteriological testing were collected in sterile, screw capped 500 mL bottles containing 0.01 % (final concentration) sodium thiosulfate. All samples were collected after flushing the spigots for 3 min according to *Standard Methods* (AMERICAN PUBLIC HEALTH ASSOCIATION, 1985). Each determination was performed by duplicate analyses. Total coliforms were enumerated by the membrane filter procedure with 0.45- μ m-pore-size membrane filters (GN-6 ; Gelman Sciences, Inc., Ann Arbor, MI.) and m-T7 agar (Difco Laboratories, Detroit, MI.) at 35 °C for 24 h. Typical coliform colonies were verified for gas production in lauryl tryptose broth (Difco) and brilliant green bile broth (Difco). Coliform bacteria were identified by using the API 20E system (Analytab Products, Plainview, N.Y.).

HPC bacteria were enumerated by the spread plate procedure with R₂A agar incubated at 20 °C for 7 days. All HPC determinations were performed by triplicate analyses. HPC bacteria on filter media were enumerated using the desorption method of CAMPER *et al.* (1985a).

Organic Carbon Analyses

Total organic carbon (TOC) was analyzed with a Photochem organic carbon Analyzer (Sybron Corp., Norwood, MA). Easily assimilable organic carbon (AOC) was determined by methods similar to the procedures of VAN DER KOOIJ and coworkers (VAN DER KOOIJ *et al.*, 1982 ; VAN DER KOOIJ and HIJNEN, 1985 ; VAN DER KOOIJ, 1987). Briefly, samples were collected in very

clean, acid washed, dry heat treated (sterile), narrow neck, glass stoppered 250 mL Pyrex glass bottles. Sodium thiosulfate (0.01 % final concentration) was added to all bottles. Samples were heat treated (70°C, for 30 min) to kill vegetative cells. Upon cooling, samples were inoculated with both *Pseudomonas fluorescens* strain P-17 and *Spirillum* strain NOX in the same bottle. Samples were incubated at 20 °C and cells enumerated after 5 and 7 days of growth. Bottles were sonicated in a Branson ultrasonic cleaning bath (Branson Cleaning Equipment Company, Shelton, CN) for 5 min prior to bacterial enumeration on R₂A agar. Individual P17 and NOX colonies were tabulated according to their distinctive colonial morphologies. The combined AOC values were calculated as acetate carbon equivalents according to published yield factors (VAN DER KOOIJ and HJNEN, 1985).

Trihalomethane Formation Potential

Samples for determination of the total trihalomethane formation potential (THMFP) were collected in headspace-free 40 mL amber bottles with teflon faced septa. The sample was buffered with 0.5 mL of concentrated pH 7.0 buffer and spiked with a sodium hypochlorite solution to achieve a final chlorine residual of 40 mg/L. Bottles were incubated for 7 days at 20°C in the dark. After incubation, the remaining free chlorine residual was determined and samples were dechlorinated with 0.2 mL of a 10 % sodium thiosulfate solution. Total THMs and appropriate field blanks and controls were determined using gas chromatography mass spectroscopy (GCtMS) by the New Jersey Department of Environmental Protection laboratory (USEPA method 624).

Chemical and Physical Analyses

Nitrate, nitrite, ortho phosphate, fluoride, chloride and sulfate were determined by ion chromatography (Dionex Model 4000i, Sunnyvale CA). Ammonia was measured using a Bausch and Lomb Spectronic 1001 spectrophotometer and colorimetric reagents from Hach Chemical Company. Oxygen levels were determined using a Model 5513-55 oxygen meter (Cole Parmer Instrument Co, Chicago, IL).

Post-Disinfection Experiments

To determine bacterial inactivation and AOC production by post-disinfection practices, 100 mL samples of preozonated or prechlorinated, GAC/sand filtered water were collected in clean, sterile bottles. Water samples were spiked with 1 mg/L free chlorine, or 2 mg/L preformed monochloramine solutions (both final concentrations). Samples were held for 30 min at 20 °C before dechlorination with 0.1 mL of a 10 % sodium thiosulfate solution. Coliform, HPC and AOC tests were performed as described above.

Quality Control and Statistical Comparisons

A quality assurance program, as outlined in *Standard Methods* (AMERICAN PUBLIC HEALTH ASSOCIATION, 1985) and *Microbiological Methods for Monitoring the Environment* (BORDNER and WINTER, 1978), was used throughout the course of study. Material used during each experiment were checked for sterility. The temperatures of autoclaves and incubators were monitored on

a per-use basis. Studies on the precision for the AOC test, including the use of positive and negative controls, have been previously published (LECHEVALLIER *et al.*, 1990). The coefficient of variation for all samples was 15.7 %. Replicate determinations of the P17 ($3.6 \pm 1.7 \times 10^6$ cells/ug, $n = 9$) and NOX ($1.38 \pm 0.15 \times 10^7$, $n = 5$) yield factors showed that it was not significantly different from that published by VAN DER KOOIJ and HIJNEN (1985).

Statistical comparisons of AOC and TOC data were performed by the paired *t*-test. Regression models and correlation coefficients were determined with the Stat-Pac statistics program (Northwest Analytical, Portland, OR) on an IBM 50/60 computer.

RESULTS AND DISCUSSION

Treatment goals for AOC

Important for the evaluation of the pilot plant results is to establish treatment goals for biologically active filters that could limit regrowth of coliform bacteria in the distribution system. Control of bacterial regrowth is a combination of improved disinfection and low nutrient levels. Previous research has suggested that regrowth of coliform bacteria in chlorinated distribution systems (1-2 mg/L free chlorine) was limited by AOC levels < 50 ug/L, as measured by strain P17 (LECHEVALLIER *et al.*, 1987, 1991). VAN DER KOOIJ has reported that HPC bacterial regrowth was limited at 10-20 ug/L in systems that practiced no post-disinfection (VAN DER KOOIJ, 1987 ; VAN DER KOOIJ *et al.*, 1989).

Figure 2 shows the relationship between total AOC (measured by both P17 and NOX) and the level of coliform bacteria in the NJAWC distribution system from December 1988 to August 1990. The results indicate that when the total AOC was < 100 ug/L, coliform bacterial levels were very low. When total AOC levels were > 180 ug/L coliform bacteria averaged 0.3 to 0.4 cells/100 mL.

The regulatory impact of the AOC data is shown in figure 3. Violation of the Total Coliform Rule (USEPA, 1989a) would have occurred when coliform bacteria were detected in more than 5 % of the monthly distribution system samples. The results shown in Figure 3 indicate that the peak occurrence of coliform bacteria (7.5 % of the samples contained coliform bacteria) coincided with average total AOC levels of 250 ug/L in the treatment plant effluent. When total AOC levels were < 100 ug/L, coliform occurrences were < 1 %.

The AOC results shown in figures 2 and 3 are much lower than what NJAWC experienced during the summer 1987 when AOC_{P17} levels were as high as 2,100 ug/L and daily coliform bacterial counts were as high as 5 cells/100 mL (LECHEVALLIER *et al.*, 1987). Overall, SRTF effluent AOC_{P17} levels average 214 ug/L in 1987 - 1988, and decreased to an average *total* AOC of 94 ug/L (21 ug/L AOC_{P17}, 73 ug/L AOC_{NOX}) in 1989-1990. This decrease in AOC levels could be attributable to the application of powdered activated carbon (PAC) into the sludge blanket reactors (LECHEVALLIER *et al.*, 1990), or improvements in raw water quality due to better management of non-point sources of pollution in the watershed.

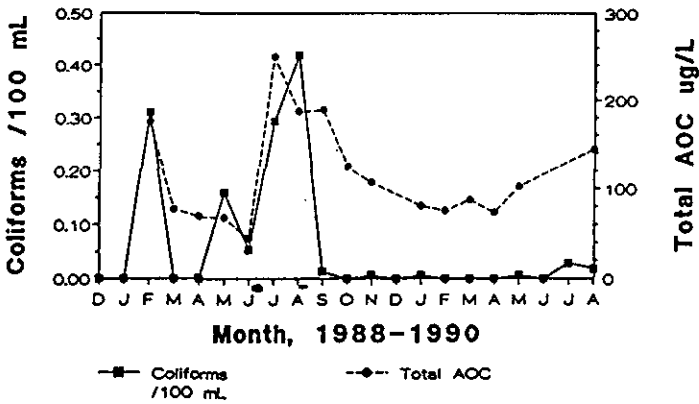

Figure 2 Relationship between mean coliform densities and total AOC. Levels, 1988-1990.

Relation entre les densités moyennes de coliformes et le COA total. Niveaux, 1988-1990.

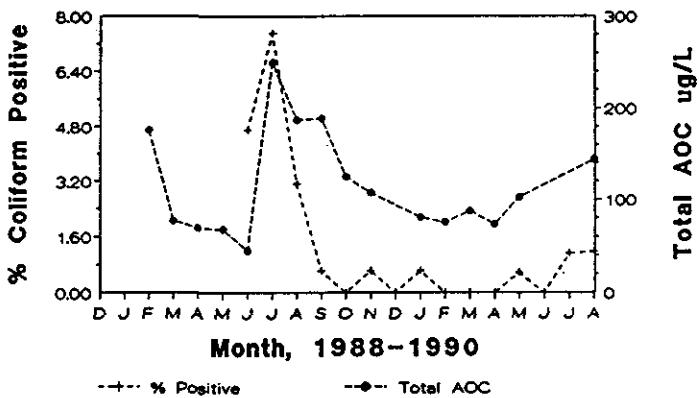

Figure 3 Relationship between percent coliform occurrence and total AOC. Levels, 1988-1990.

Relation entre le pourcentage de présence de coliformes et le COA total. Niveaux, 1988-1990.

The results of the current study are supported by previous observations (LECHEVALLIER *et al.*, 1987, 1990, 1991), showing that regrowth of coliform bacteria can be limited at AOC levels between 50 and 100 ug/L. This is not to say that systems with high AOC (> 100 ug/L) will experience coliform regrowth. Bacterial growth is dependent upon a complex combination of physical and chemical factors. However, for systems experiencing bacterial regrowth, effective disinfection and reduced AOC levels should help resolve the problem. The level of secondary disinfection (e.g., the residuals maintained in the distribution system) could be lowered if AOC levels can be reduced to very low levels (VAN DER KOOIJ, 1987; SCHELLART, 1986). Therefore, the goal

of a biologically active treatment process should be to reduce AOC levels as much as possible. In the NJAWC system, total AOC levels should be reduced to at least to <100 ug/L.

Evaluation of filter media for biological treatment

Table 2 shows the three different media configurations tested during the pilot plant trials for biological treatment. The mixed media filter (anthracite, sand and garnet) was evaluated because it was the configuration used in the SRTP. The GAC/sand and deep bed GAC configurations are often retrofitted as filter/adsorbers (GRAESE *et al.*, 1987). For all the media configuration trials the raw water was preozonated at a ratio of 0.5-1.0 mg/L ozone to 1 mg/L TOC. Filter effluents were not post disinfected.

Mixed Media and GAC/sand Filters

Figure 4 shows a comparison between the mixed media filter and the GAC/sand filter for removal of AOC. AOC levels averaged 380 ug/L in the raw water and increased to 780 ug/L after ozonation. The mixed media filter reduced AOC levels to an average of 192 ug/L (75.3 %), whereas the GAC/sand filter reduced AOC levels to an average of 106 ug/L (86.4 % ; for AOC reduction the percent removal was calculated as the difference between the AOC in the effluent of the ozone contactor and the filter effluent). The increased biological activity of the GAC/sand filter was evidenced by a 5.4 fold higher HPC bacterial count in the filter effluent (7.54×10^4 cfu/mL for the GAC/sand, compared to 1.41×10^4 cfu/mL for the mixed media filter), and bacterial counts on the filter media were 37 times higher for the GAC/sand filter (3.6×10^8 cfu/g) than the mixed media filter (9.7×10^6 cfu/g).

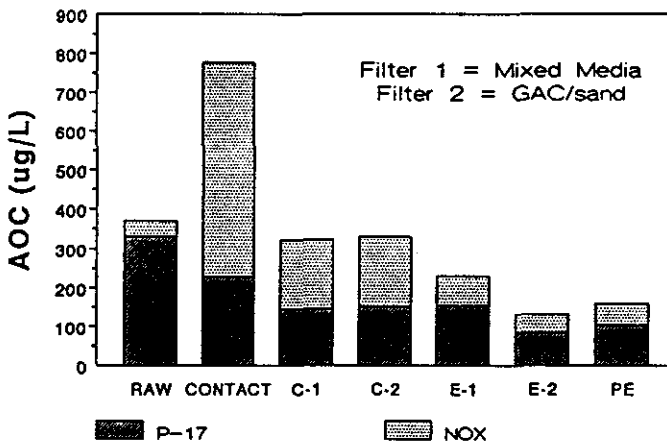

Figure 4 AOC removal by mixed media and GAC/sand filters. C-1 and C-2 are the clarifier basins, E-1 and E-2 are the filter effluents, PE is the SRTP effluent.

Suppression du COA par filtres de milieu mixte et filtres CAG/Sable. C-1 et C-2 sont les bassins de clarification, E-1 et E-2 sont les effluents des filtres, PE est l'effluent de SRTP.

The increase in biodegradation rates for GAC filters relative to non-adsorbing media may be due to better utilization of sorbed substrate, higher surface area, and a more favorable acclimation environment (COMMITTEE REPORT, 1981 ; LI and DIGIANO, 1983 ; KUROSAWA *et al.*, 1987). LI and DIGIANO (1983) attributed higher biodegradation and specific growth rates on GAC to utilization of internally sorbed substrate. The enhanced specific growth rate increased with the concentration of sorbed substrate and with decreasing particle size, suggesting that the rate of internal diffusion was important. Because the GAC used in this set of experiments was not pre-exhausted for adsorption of organics, it is likely that AOC reductions were a combination of biological and adsorptive processes. The higher surface area of GAC relative to sand or anthracite means that GAC filters can support a larger bacterial population (COMMITTEE REPORT, 1989). Specialized GAC has been developed (PICABIOL ; PICA, Levallois, France) with a macroporous structure designed to accommodate large bacterial populations.

KUROSAWA *et al.*, (1987) reported that GAC filters were more active, at lower temperatures, than rapid sand filters. At water temperatures of 17 °C, the removal of ammonia by biologically active GAC was approximately equal to sand filters. As water temperatures declined to 10 °C, the biological activity of sand filters was virtually eliminated, whereas the GAC filters was nearly 100 %. The comparison of GAC/sand and mixed media filters in figure 4 was performed between 1/20/89 and 3/10/89 when raw water temperature averaged 3.5 °C. The difference in efficiency of AOC removal between mixed media and GAC/sand filters may be less pronounced when water temperatures are higher.

Comparison of mixed media and GAC/sand filters for TOC removal is shown in figure 5. In contrast to the increase in AOC, preozonation had little effect on direct oxidation. The GAC/sand filter averaged a 51 % removal of TOC, where the mixed media filter removed 26 % of the raw water TOC. Figure 5 shows that the mixed media filter in the pilot plant had the same treatment efficiency for TOC as the SRTP.

Table 3 summarizes the treatment parameters for the filter configurations studied. Both mixed media and GAC/sand filters produced water with low effluent turbidities (average 0.16 NTU). Evaluation of the turbidity data showed that 95 % of the turbidity values were < 0.5 NTU. All of the high turbidity values occurred during the beginning of the study when the filters were being acclimated and coagulant rates adjusted. After 24 h of operation the mixed media filter averaged 5.8 ft head loss, whereas the GAC/sand filter averaged 5.3 ft head loss. These results show that biologically active filters can operate with low effluent turbidity and acceptable filter run times.

BABLON *et al.* (1988) found that biologically active GAC/sand (16 in GAC over 24 in sand) filters performed better than monomedia sand filters. The GAC/sand filter had better turbidity removal, longer filter runs, less head loss development, greater biological activity, and was less affected by changes in water temperature. Although the dual media filter was not as effective for AOC removal as sand filters followed by GAC filtration, the authors concluded that GAC/sand filters were an economical and practical alternative to two filters in series.

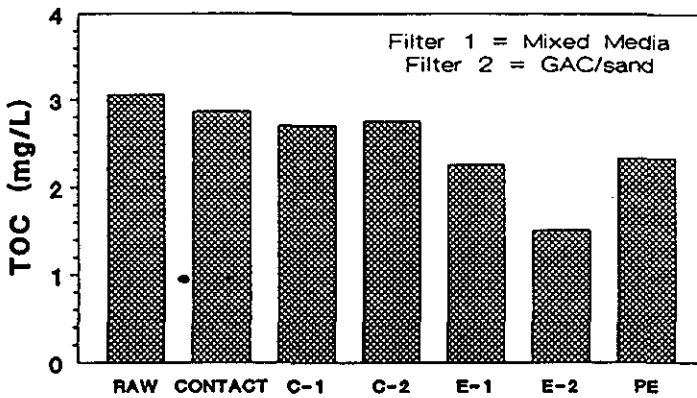

Figure 5 TOC removal by mixed media and GAC/sand filters. C-1 and C-2 are the clarifier basins, E-1 and E-2 are the filter effluents, PE is the SRTF effluent.

Suppression du COT par filtres de milieu mixte et filtres CAG/Sable. C-1 et C-2 sont les bassins de clarification, E-1 et E-2 sont les effluents des filtres, PE est l'effluent de SRTF.

Table 3 Summary of treatment parameters.

Tableau 3 Sommaire des paramètres de traitement.

Media configuration	Preoxidant mg/L	N	Turbidity NTU	Head loss ft	EBCT min	Oxidant mg/L
Mixed media	Ozone	108	0.16	5.8	—	0.35
GAC/sand	Ozone	108	0.16	5.3	5	0.35
Deep bed GAC	Ozone	153	0.30	2.0	14	0.26
GAC/sand	Ozone	153	0.27	3.8	7	0.26
GAC/sand	Ozone	62	0.22	2.9	10	0.20
GAC/sand	Chlorine/Dechlor	62	0.24	3.0	10	—*
GAC/sand	Ozone	138	0.15	2.6	10	0.32
GAC/sand	Chlorine	138	0.26	2.7	10	3.0*
GAC/sand	Chloramine	138	0.29	2.5	10	3.0*
GAC/sand	Ozone	68	0.46	2.9	7	0.31
GAC/sand	None	68	0.32	4.3	7	0.0

All values are for filter effluent except for oxidant concentrations which are for the contactor effluent. Values marked with an asterisk are for samples collected from the effluent of the settling basin. Water was dechlorinated with sodium thiosulfate after the settling basin sample point. EBCT was calculated for the GAC portion of the filter.

Toutes les données sont valables pour les effluents sortant du filtre, sauf pour les concentrations d'oxydant qui sont valables pour les effluents sortant du contacteur. Les données marquées d'un astérisque sont valables pour des échantillons prélevés de l'effluent du bassin de décantation. L'eau a été déchlorée avec du thiosulfate de sodium après le prélèvement d'échantillon du bassin de décantation. La TRLV était calculée pour la partie du filtre de CAG.

GAC/sand and Deep Bed GAC Filters

Comparison of GAC/sand and deep bed GAC filters (see table 2 for configuration) was conducted between 3/13/89 and 5/15/89 when water temperatures averaged 10.5 °C (table 1). Both filters proved effective for removal of AOC (fig. 6). The deep bed GAC filter averaged 86 % removal of AOC, whereas the GAC/sand filter averaged 85 % AOC removal. The effluent of both filters averaged 50-55 ug/L total AOC. Viable counts of bacterial populations in the GAC filters showed no significant difference between the deep bed GAC and the GAC/sand filters (2.6×10^8 cfu/g and 2.9×10^8 cfu/g, respectively).

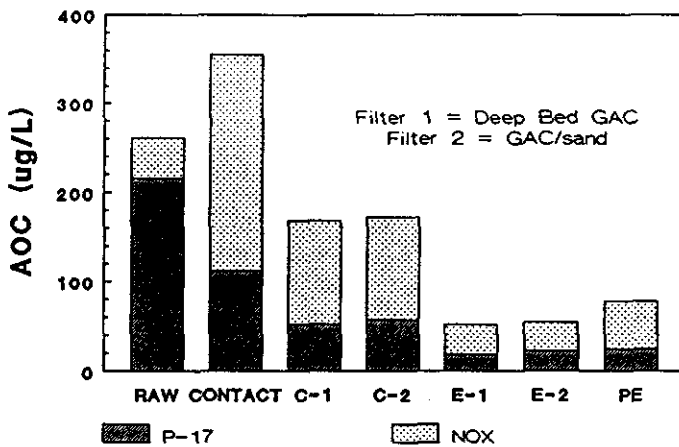

Figure 6 AOC removal by GAC/sand filters and deep bed GAC filters. C-1 and C-2 are the clarifier basins, E-1 and E-2 are the filter effluents, PE is the SRTP effluent.

Suppression du COA par filtres CAG et filtres CAG en lit vide. C-1 et C-2 sont les bassins de clarification, E-1 et E-2 sont les effluents des filtres, PE est l'effluent de SRTP.

Analysis of TOC levels in the filter effluents showed that the deep bed GAC filter had slightly better TOC removal than the GAC/sand filter (fig. 7). This difference of 0.15 mg/L was thought to be due to the greater adsorptive capacity of the deep bed filter. The difference in empty bed contact time (EBCT) may also have contributed to the slightly lower TOC levels.

Operational parameters summarized in table 3 show that both filters produced low turbidity and low head loss levels. The increase in average turbidity level compared to the mixed media – GAC/sand trials was due to a problem in the operation of the pilot plant. During this period, the ozone feed line developed a leak. When the ozonator was shut down for repairs, the filter effluent turbidity increased. This increase was attributed to the lack of improved coagulation afforded by ozonation. After the ozone feed line was repaired, effluent turbidities averaged 0.1 NTU.

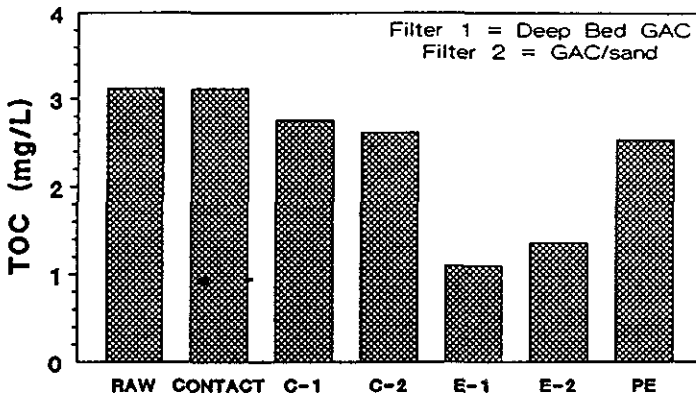

Figure 7 TOC removal by GAC/sand filters and deep bed GAC filters. C-1 and C-2 are the clarifier basins, E-1 and E-2 are the filter effluents, PE is the SRTP effluent.

Suppression du COT par filtres CAG et filtres CAG en lit vide. C-1 et C-2 sont les bassins de clarification, E-1 et E-2 sont les effluents des filtres, PE est l'effluent de SRTP.

Summary of Filter Media Comparisons

The results of this study showed that GAC media performed better than mixed media for treatment of AOC and TOC. The characteristics of GAC provide for a suitable habitat for the large bacterial populations needed for effective biodegradation. Although the deep bed GAC filter performed slightly better than the GAC/sand filter, the latter is most easily retrofitted to current treatment designs. Because of its applicability, pre-exhausted GAC/sand filters were used in all of the following experiments. All the filters tested performed well with respect to effluent turbidity and head loss development.

Evaluation of preoxidants for biological filtration

Preoxidants are used in the treatment of water for a variety of purposes including: disinfection of pathogenic microorganisms, oxidation of reduced iron and manganese, taste and odor control, oxidation of natural and synthetic compounds, and chemical conditioning of the water. Application of the best preoxidant (ozone, chlorine, chloramines, chlorine dioxide, or permanganate) will depend on the specific conditions at each facility. A careful selection of a series of oxidants can maximize the benefits, and reduce the risks of each compound.

It is beyond the scope of this project to evaluate all of the consequences of oxidant pretreatment. Instead, experiments were designed to evaluate the compatibility of various preoxidants with biologically active GAC/sand filtration. Experimental parameters included use of ozone, free chlorine, monochloramine, and use of no predisinfectant. In some trials the chlorine residual was neutralized with sodium thiosulfate prior to filtration.

Preozonation and Chlorine/Dechlorination

Comparison of preozonation and chlorine/dechlorination (e.g., neutralization of the chlorine residual prior to filtration) was performed from 1/22/90 to 5/28/90. During this time, raw water turbidity ranged from 3.2 to 4.0 NTU, and water temperature ranged from 4.7 to 12.7 °C (table 1). Ozone dosages ranged from 2.5 to 2.8 mg/L, and achieved residuals after 10 min contact of 0.2 to 0.5 mg/L. No ozone residual was detected after the settling basin (fig. 1). Free chlorine doses were calculated at 5.0 mg/L, and residuals ranged between 1.7 and 2.7 mg/L in the effluent of the settling basin. Thiosulfate was injected into the pipe between the settling basin and the filter to neutralize the residual chlorine. The GAC/sand filters were operated with an EBCT of 10 min.

The effect of preozonation and free chlorination/dechlorination on the ability of biologically active GAC/sand filters to remove AOC is shown in figure 8. AOC levels in the preozonated filter effluent averaged 79 ug/L, whereas the prechlorinated/dechlorinated filter effluent averaged 50 ug/L. This difference was statistically significant ($p = 0.0003$; $n = 46$).

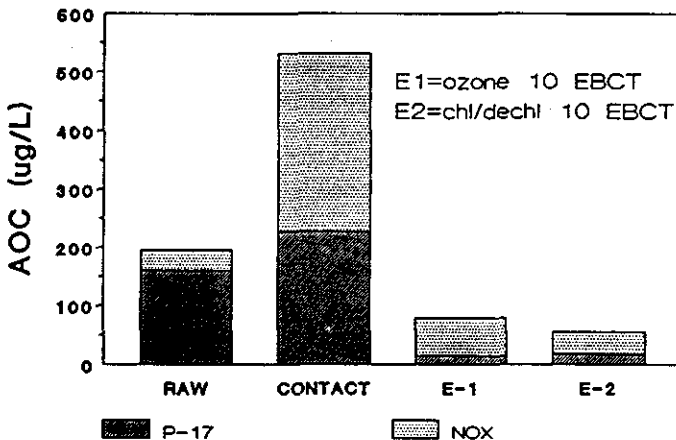

Figure 8 AOC removal by preozonated and chlorinated/dechlorinated GAC/sand filters. E-1 and E-2 are the filter effluents.

Suppression du COA par filtres pré-ozonés et chlorés/déchlorés GAC. E-1 et E-2 sont les effluents des filtres.

The higher AOC levels in the preozonated filter effluent could be attributed to the large increase in biodegradable material caused by ozonation. On average, ozonation increased AOC levels 2.3 fold over raw water values. The increase biodegradability of ozonated water has been observed by many investigators (LANGLAIS *et al.*, 1981; CROWE and BOUWER, 1987; FAUST and ALY, 1987; HUCK and TOFT, 1987; RITTMANN and HUCK, 1989). The amount of increase in AOC has been shown to be dependent upon the ratio of TOC to ozone dose (VAN DER KOOIJ *et al.*, 1989). The maximum rate of AOC formation occurred at ozone to TOC ratios ranging between 1-2 (mg O₃/mg carbon).

Prechlorination of raw water also increased AOC levels, although direct comparison of the magnitude of the increase to ozone was difficult. Samples were collected after chlorination and held for 10 min (to simulate the detention of the ozone contactor). Analysis of these chlorinated samples for AOC often showed inhibition presumably due to the presence of alum coagulants, which were injected at the same location as the chlorine. HUCK (1990) has observed inhibition of P17 by polyaluminium chloride. A survey of 8 water systems in the Netherlands showed that chlorination (0.3 to 2.0 mg/L) increased AOC an average 1.75 fold (COOPERATIVE RESEARCH REPORT, 1988). The increase in AOC was thought to be due to the production of low – molecular-weight compounds by oxidation of humic and fulvic acids (DE LEER *et al.*, 1985). Both preozonated and free chlorinated/dechlorinated filters achieved a 33 % reduction of TOC from raw water values. TOC levels in the preozonated filter effluent averaged 1.62 mg/L, whereas the prechlorinated/dechlorinated filter effluent averaged 1.63 mg/L.

Ozone, Free Chlorine and Chloramination

Initial experiments performed 10/18/89 to 11/20/89, compared AOC removal in preozonated and prechlorinated GAC/sand filters. Water temperature averaged 4.7 °C, and raw water turbidity averaged 3.2 NTU (*table 1*). AOC levels in the filter effluents averaged 74 ug/L for the preozonated filter, and 46 ug/L for the prechlorinated filter. The prechlorinated filter consistently produced AOC levels lower than the preozonated filter (*fig. 9*). Preozonation increased AOC levels to the extent (368 ug/L) that even an 80 % removal efficiency resulted in higher effluent results.

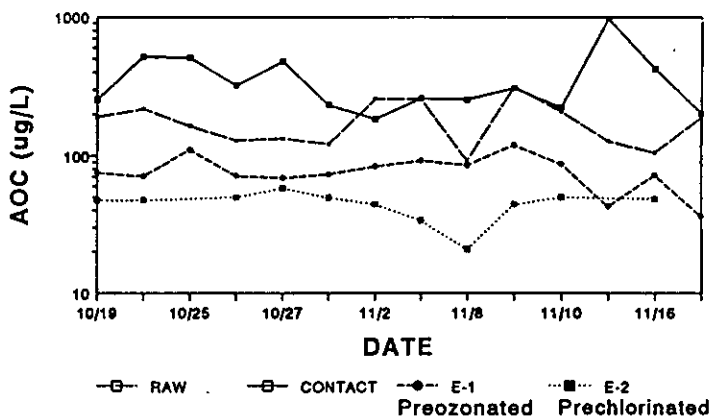

Figure 9 AOC removal by preozonated and prechlorinated GAC/sand filters. Contact, effluent of the ozone contactor, E-1 and E-2 are the filter effluents.

Suppression du COA par filtres pré-ozonés et chlorés/déchlorés GAC. Contact, effluent du contacteur d'ozone. E-1 et E-2 sont les effluents des filtres.

Additional experiments comparing preozonation, prechlorination, and prechloramination were performed from 5/29/90 to 7/30/90. During this time, raw water turbidity averaged 2.4 NTU, and water temperature averaged 23.7 °C (table 1). Ozone dosage ranged from 2.5 to 2.8 mg/L, and achieved residuals after 10 min contact averaging 0.32 mg/L. No ozone residual was detected after the settling basin (fig. 1). Free chlorine was dosed at 5.0 mg/L into the chemical mixed line, and residuals averaged 3.0 mg/L in the effluent of the settling basin. Ammonia (ammonium chloride) was injected into the pipe between the settling basin and one of the filters to convert free chlorine to chloramines (3:1 chlorine to ammonia ratio). The GAC/sand filters were operated with an EBCT of 10 min.

The effect of preozonation, prechlorination and prechloramination on the ability of biologically active GAC/sand filters to remove AOC is shown in figure 10. AOC levels in the preozonated filter effluent averaged 86 ug/L, the prechloraminated filter effluent averaged 71.5 ug/L, and the prechlorinated filter effluent averaged 53 ug/L. The difference in AOC between the prechlorinated filter effluent and the preozonated or the prechloraminated filter effluent were statistically significant ($p = 0,0001$, and $p = 0,009$, respectively ; $n = 34$). The difference in AOC between the preozonated and the prechloraminated effluents were not statistically different ($p = 0,11$; $n = 34$).

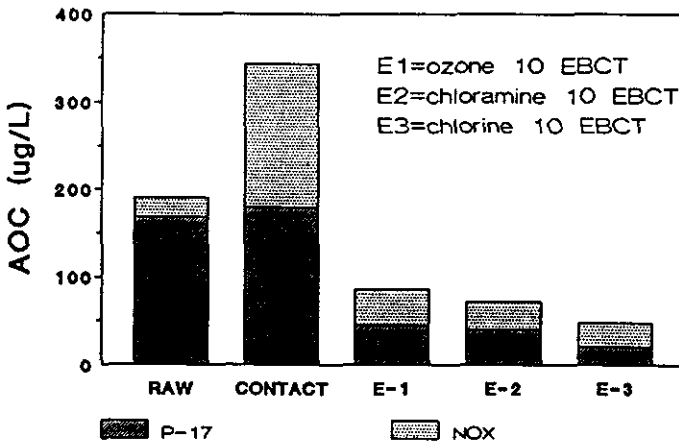

Figure 10 AOC removal by preozonated, prechlorinated and prechloraminated GAC/sand filters. The chlorine and chloramine residuals were not neutralized prior to filtration. E-1 and E-2 are the filter effluents.

Suppression du COA par filtres de CAG/Sable pré-ozoné, pré-chloré, pré-chloraminé. Les résidus chlorés et chloraminés n'ont pas été neutralisés avant la filtration. E-1 et E-2 sont les effluents des filtres.

It was the initial intent of these experiments to kill the attached bacterial populations. However, the free chlorine residuals were rapidly neutralized within the GAC filters and biological processes proceeded unimpaired. Chloramines are a more stable disinfectant and residuals averaging 0.1 mg/L

(range 0 to 0.4 mg/L) were detected in the filter effluent. HPC bacterial counts in the effluent of the prechloraminated filter averaged 8.93×10^2 cfu/mL, compared to 1.16×10^4 cfu/mL and 1.22×10^4 cfu/mL for the preozonated and prechlorinated filter effluents, respectively. Evidently, there was sufficient microbial activity within the pores of the GAC filter, even in the presence of a chloramine residual, for AOC removal. It is also possible that the excess ammonia from the chloramination process may have stimulated bacterial growth.

Comparison of preozonation and prechloramination continued during 7/31/90 to 9/1/90. It was of interest to see if continued chloramination would eventually reduce microbial activity within the filters. Results showed that the effluent of the prechloraminated filter continued to produce slightly lower AOC levels than the preozonated filter. AOC levels averaged 63 $\mu\text{g/L}$ in the prechloraminated effluent, whereas the preozonated filter effluent averaged 86 $\mu\text{g/L}$. TOC levels in the filter effluents averaged 2.5 mg/L for the preozonated system, and 2.9 mg/L for the prechloraminated system.

The important result from these experiments is that AOC reduction still occurred within GAC filters even in the presence of a disinfectant residual. These results imply that many conventionally operated GAC filters may already achieve good AOC removals. It is interesting that many of the published bacterial regrowth problems have occurred in systems that did not practice GAC filtration (HUDSON *et al.*, 1983 ; REILLY and KIPPEN, 1983 ; LOWTHER and MOSER, 1984 ; LUDWIG, 1985 ; OLIVIERI *et al.*, 1985 ; LECHEVALLIER *et al.*, 1987). Future research should evaluate AOC removals in a variety of treatment chains.

In contrast to AOC removals, the preozonated filter effluent produced the lowest TOC levels (1.69 mg/L), while the prechlorinated and prechloraminated filters averaged TOC levels of 2.18 and 2.22 mg/L, respectively. The results were statistically different ($p < 0,0001$ for both ozone-chlorine and ozone-chloramine ; $n = 20$), and highlight the difference between AOC and TOC determinations. VAN DER KOOIJ and HIJNEN (1985), VAN DER KOOIJ (1987) and LECHEVALLIER *et al.* (1991) have previously pointed out the lack of correlation between AOC and TOC. The results of this study are consistent with those of other investigators (CROWE and BOUWER, 1987 ; FAUST and ALY, 1987 ; HUCK and TOFT, 1987 ; RITTMANN and HUCK, 1989) who have shown that preozonation can improve TOC removals relative to prechlorination. Reduced TOC levels can be associated with lower chlorine demand, lower disinfection by-products, and reduced taste and odors. However, dechlorination of the residual before filtration was shown to produce TOC removals equivalent to those for preozonation.

Ozone and No Preoxidant

For many systems preoxidants are needed to chemically oxidize compounds and condition the water. In addition, many systems need to predisinfect the water to meet CxT criteria outlined by the Surface Water Treatment Rule (USEPA, 1989b). Therefore, for many systems there is no option not to add preoxidants. However, some systems could delay addition of oxidants until after filtration with no adverse effect on coagulation or filtration.

Experiments comparing preozonation and no preoxidation on the performance of GAC/sand filters were conducted on 5/22/89 through 8/9/89 when water temperatures averaged 19.4 °C (table 1). AOC levels averaged 100 µg/L in the preozonated filter effluent, and 92 µg/L in the filter effluent with no preoxidation (fig. 11) higher AOC levels in the preozonated effluent is consistent with the other experiments presented in this study.

One advantage of preozonation was that oxygen levels were saturated in the treated water. Even after biologically active filtration, oxygen levels averaged 3.0 mg/L higher than in the effluent with no preoxidation. The biologically active filter with no preoxidation had oxygen levels averaging 1.65 mg/L lower than the conventional plant effluent. Low oxygen levels (< 1 mg/L) could eventually lead to black water (anaerobic conditions) in the distribution system, taste and odor problems, and interfere with the effectiveness of chlorine disinfection (WHITE, 1986).

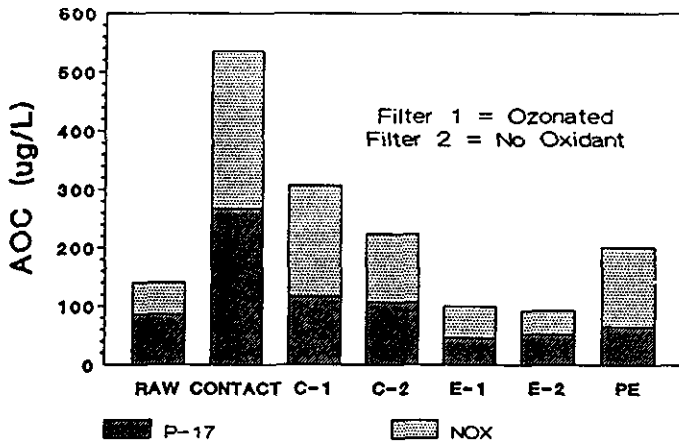

Figure 11 AOC removal by preozonated and non-preoxidated GAC/sand filters. C-1 and C-2 are the clarifier basins, E-1 and E-2 are the filter effluents, PE is the SRTP effluent.

Suppression du COA par filtres de CAG/Sable pré-ozoné et non-préoxydé. C-1 et C-2 sont les bassins de clarification, E-1 et E-2 sont les effluents des filtres, PE est l'effluent de SRTP.

Effect of empty bed contact time on aoc and toc removal

The effect of EBCT on AOC removal is shown in figure 12. For these experiments, the GAC/sand filters were in operation for more than a year and were preozonated. EBCT was increased by decreasing the flow rate (hydraulic loading) to each filter. As EBCT increased from 5 min to 20 min, total AOC levels decreased from an averaged of 82 µg/L at an EBCT of 5 min, 73 µg/L at 10 min EBCT, 69 µg/L at 15 min EBCT and to an average of 47 µg/L at 20 min EBCT. Similar to AOC, TOC removals increased from 29.0 % at 5 min EBCT, 33 % at 10 min EBCT, 42 % at 15 min EBCT, to 51.2 % at EBCT of 20 min.

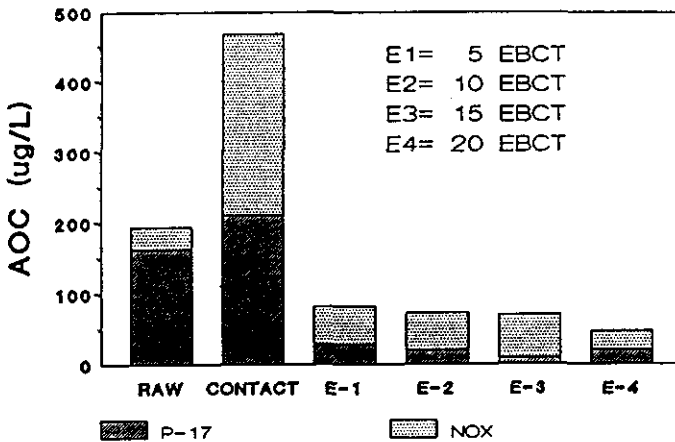

Figure 12 AOC removal by GAC/sand filters at different EBCTs. All filters were preozonated.

Suppression du COA par filtres de CAG/Sable à des TRVL différents. Tous les filtres ont été pré-ozonés.

PREVOST *et al.* (1990) reported that 62-90 % of the AOC was removed with 2 min contact time in biologically active filters, but that 10-20 min was required to remove 90 % of the BDOC. Reduced BDOC levels were associated with increased chlorine stability within the distribution system. SONTHEIMER and HUBELE (1989) reported that DOC removal increased from 27 % to 41 % as residence time within biologically active GAC filters increased from 5 to 20 min. They reported that residence time, and not filter velocity, source of GAC material, or particle diameter, was important for DOC removal. They also recommend that a 15 to 20 min EBCT be used in design criteria for biologically active filtration. Our study shows that a 15-20 min EBCT may be needed for TOC removal, but may be excessive for treatment of AOC, especially if the intent is to control coliform regrowth (i.e., total AOC < 100 ug/L). Turbidity and headloss values for the GAC/sand filters operated at different EBCTs are shown in table 4. Turbidity and headloss values decreased as filtration rates decreased and EBCTs increased.

Table 4 Summary of treatment parameters for EBCT trials.

Tableau 4 Sommaire des paramètres de traitement des essais du TRLV.

EBCT min	N	Filtration rate gal.min/ft ²	Turbidity NTU	Head loss ft
5	99	0.34	0.31	5.4
10	145	0.17	0.19	2.4
15	139	0.14	0.14	1.3
20	145	0.11	0.16	2.3

Turbidity values are averages of all measured values. Headloss values are averages after 24 h of operation.

Les données de turbidité sont les moyennes de toutes les données mesurées. Les pertes d'écoulement sont les moyennes après 24 h d'usage.

Biological treatment and removal of THM precursors

For systems without bacterial regrowth problems, application of biological processes may be attractive for treatment of THM and other disinfection by-product precursors.

A significant ($r = 0.93$; $p < 0,01$; $n = 51$) relationship was found between THMFP and TOC (fig. 13). The results show for the NJAWC source water that TOC levels < 2 mg/L, can be related to a THMFP of < 100 ug/L. Therefore, any process that reduces TOC levels, will also reduce THMFP. TOC is known to be an important predictor of THM levels (SYMONS *et al.*, 1975; SINGER and CHANG, 1989; CHANG and SINGER, 1991). However, other parameters that are important in THM formation include temperature, pH, free chlorine dose, reaction time, and bromide concentration (SYMONS *et al.*, 1981). Many of the treatment processes examined in this study reduced TOC levels to < 2 mg/L, and it is clear that reduction of THMFP is accomplished by a variety of biological processes.

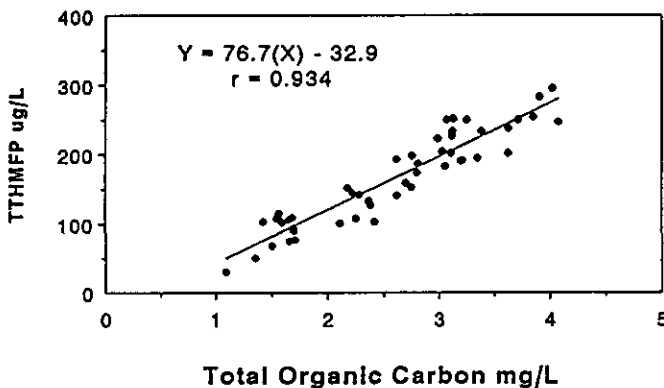

Figure 13 Relationship between total trihalomethane formation potential (THMFP) and TOC. Values represent samples from all stages of treatment.

Relation entre la formation potentielle de méthane tri-halogéné (FPMTH) et le COT. Les données représentent des échantillons de toutes les étapes du traitement.

Data shown in figure 14 indicate that biologically active GAC/sand filtration (10 min EBCT) could produce a steady state reduction in THMFP of 54 % over a one year period. During the initial 60 days of operation THMFP removals were 76 to 84 % until the adsorbance capacity of the filter was exhausted. THMFP levels in the filter effluent averaged 99 ug/L (107 ug/L after the initial 60 days). For comparison, THMFP levels in the SRTP effluent averaged 178 ug/L over the same time period. Not only was the THMFP decreased by biological treatment, but avoiding prechlorination (by use of ozone) would have resulted in lower actual THM levels in the distribution system.

Table 5 summarizes the disinfection by-products formed by the preozonation and prechlorination processes. Trihalomethanes, total organic halides,

haloacetonitriles, chloral hydrate and total halo ketones were higher in the prechlorinated system than in the ozonated system. There was no difference in chloropicrin levels between the two treatment chains. Aldehydes and haloacetic acids were not measured.

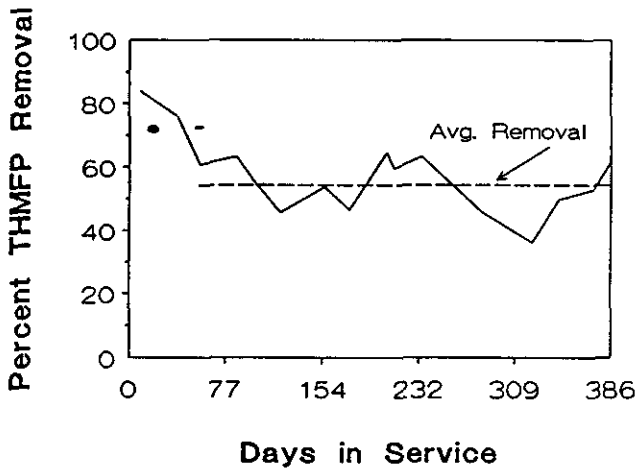

Figure 14 Efficiency of biologically active filters for THMFP removal. GAC/sand filters were preozonated and operated at 10 min EBCT.

Efficacité des filtres biologiquement actifs par la suppression du FPMTH. Les filtres de CAG/Sable étaient pré-ozonés et utilisés pendant 10 minutes de TRLV.

Post disinfection of biologically treated effluents

A major concern with biological treatment is the introduction of bacteria from the filters themselves. HPC bacterial counts in pretreated effluents ranged from 8.97×10^2 to 3.82×10^4 cfu/mL. However, coliform bacteria were rarely observed in biologically treated effluents. It is possible that coliform organisms were eliminated by the vigorous microbial activity within the filters (CAMPER *et al.*, 1985b ; ROLLINGER and DOTT, 1989).

Post disinfection (30 min contact time) of preozonated or prechlorinated/dechlorinated GAC/sand filter effluents with free chlorine (1 mg/L) or preformed monochloramine (2 mg/L) reduced HPC bacterial levels by 2-2.5 \log_{10} (fig. 15). In each case, the free chlorine residual produced slightly better inactivation rates than the preformed chloramines. By comparison, the SRTP produced HPC bacterial levels 0.5 \log_{10} lower than the pilot plant studies, although the disinfection contact time of the SRTP was much longer (1 hour) and filter effluent HPC levels were probably lower.

The effect of post disinfection on the secondary rise in AOC levels is shown in figure 16. Water from the preozonated filter showed virtually no increase (< 8 %) in AOC levels when treated with 1 mg/L free chlorine or 2 mg/L monochloramine for 30 min. Samples from the prechlorinated/dechlorinated

GAC/sand filter effluent showed a 20 % increase in AOC when chlorinated, and 44 % increase in AOC when chloraminated for 30 min. The total AOC level for the prechlorinated/dechlorinated GAC/sand effluent upon post disinfection was still lower than for the preozonated filter.

Table 5 Summary of disinfection by-product analysis.

Tableau 5 Sommaire des analyses de sous-produits de désinfection.

Test parameter	Raw water	Settled preozonated	Settled prechlorinated	Effluent preozonated	Effluent prechlorinated
pH units	6.9	7.3	7.6	6.9	6.7
Temperature (°C)	8.9	10	10	11	11
TOC (mg/L)	3.9	4.1	4.4	2.9	2.9
Chloride (mg/L)	17.7	17.9	23.1	18.2	23.8
Bromide (mg/L)	0.04	0.04	< 0.02	0.04	0.02
% UV Reduction	0	71.4	42.9	85.7	57.1
Total Organic Halide		37	250	30	170
Trihalomethanes					
Chloroform		1.0	21	3	32
Bromodichloromethane		< 0.05	5.0	< 0.05	7
Dibromochloromethane		< 0.05	< 0.05	< 0.05	1
Bromoform		< 0.05	< 0.05	< 0.05	< 0.05
Total		1.0	26	3	40
Haloacetonitiles					
BCAN		< 0.02	1.18	< 0.02	< 0.02
DBAN		< 0.02	0.13	< 0.02	< 0.02
DCAN		0.05	2.08	< 0.02	0.48
TCAN		< 0.02	1.16	< 0.02	< 0.02
Total		0.05	4.5	< 0.02	0.48
Chloral Hydrate		0.61	3.01	< 0.02	1.96
Chloropicrin		< 0.02	0.68	< 0.02	< 0.02
Halo ketones					
DCP		0.12	0.72	0.1	0.48
TCP		0.71	2.06	0.76	0.7
Total		0.83	2.78	0.86	1.18

All analyses were performed by the USEPA Cincinnati laboratory according to accepted procedures. All values are $\mu\text{g/L}$, unless indicated otherwise. No disinfection by-product analyses were performed on raw water samples. Chlorine residuals were not neutralized prior to GAC/sand filtration. EBCT, 7 min.

Toutes les analyses ont été faites au laboratoire de l'US EPA à Cincinnati suivant les méthodes officielles. Toutes les données sont exprimées en $\mu\text{g/L}$, sauf indication contraire. Aucune analyse de sous-produits de désinfection n'a été faite sur les échantillons d'eau brute. Les résidus de chlore n'ont pas été neutralisés avant la filtration par un filtre de GAG/Sable. Le TRLV était de sept minutes.

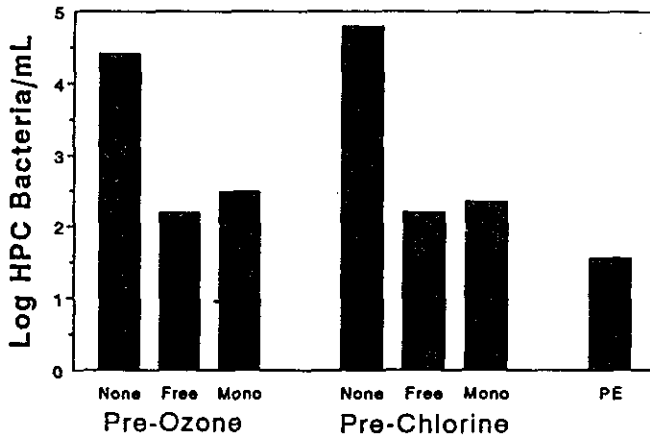

Figure 15 Disinfection of HPC bacteria in preozonated and prechlorinated filter effluents. Samples were exposed to 1 mg/L free chlorine and 2.0 mg/L preformed monochloramine for 30 min.

Désinfection de bactéries hétérotrophes dans les effluents des filtres pré-ozonés et pré-chlorés. Les échantillons furent assujettis à 1 mg/L de chlore libre et 2.0 mg/L de monochloramine pré-formée pendant 30 minutes.

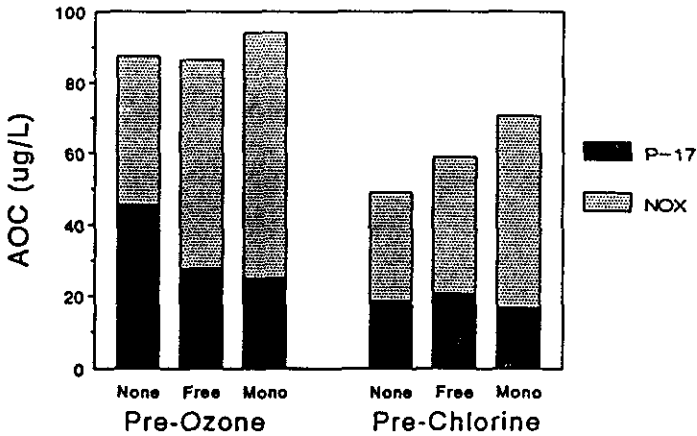

Figure 16 Effect of post-disinfection on AOC levels. Samples were exposed to 1 mg/L free chlorine and 2.0 mg/L preformed monochloramine for 30 min.

Effet de la désinfection postérieure sur les taux de COA. Les échantillons furent assujettis à 1 mg/L de chlore libre et 2.0 mg/L de monochloramine pré-formée pendant 30 minutes.

CONCLUSIONS

The ability of biologically active GAC/sand filter absorbers to produce low turbidity, acceptable run times (> 24 h), reduced THMFPs and effluent AOC levels < 100 ug/L, indicate that these systems could be readily applied to current water treatment systems. The choice of preoxidant will depend on the particular needs of the water system. Preozonation can provide many benefits to the water treatment process (disinfection, avoid THM formation, microflocculation, enhanced biological activity, etc.), however, effluent AOC levels may be higher than in non-ozonated systems. If the sole intent is to limit bacterial regrowth by production of low AOC water, options other than preozonation may be more effective. Specific conclusions include :

1. At the Swimming River Treatment Plant AOC levels < 100 ug/L may be necessary to control excessive bacterial regrowth within the distribution system. Regrowth of coliform bacteria can violate the Total Coliform MCL.

2. GAC filter media can support a larger bacterial population, and thus, provide better biological removal of AOC and TOC than conventional filter media. GAC filters can remain active (> 80 % AOC removal) even at low water temperature.

3 Deep Bed GAC filters slightly outperformed GAC/sand filters for AOC and TOC removal. This better performance was attributed to the greater EBCT.

4. All biologically active filters showed good performance relative to effluent turbidity levels and headloss development. The results suggest that biologically active filters could perform similarly to conventional filtration.

5. Preozonation of raw water increased AOC levels an average of 2.3 fold, and always increased filter effluent AOC levels relative to nonozonated water.

6. Application of free chlorine to GAC filters did not inhibit AOC removals. The results suggest that many conventional GAC filters may already be achieving good AOC removals. Prechlorination resulted in significantly lower effluent AOC levels than did preozonation.

7. Application of chloramines to GAC filters showed a slight inhibitory effect relative to free chlorine. The stability of chloramine residuals allowed the disinfectant to penetrate the filter and achieve trace residuals in the filter effluent. HPC bacterial levels in prechloraminated filters were more than 10 times lower than in prechlorinated or preozonated filters.

8. EBCT increased both AOC and TOC removal efficiencies. However, AOC levels < 100 ug/L could be achieved with 5-10 min EBCT. Effective TOC removal (> 50 %) required long (20 min) EBCT.

9. THMFP were related to TOC levels. Processes that decreased TOC levels also decrease THMFP. Prechlorination produced a variety of disinfection byproducts, chiefly THMs and haloacetonitriles. THMFP levels in the SRTP could be reduced in half by use of biologically active GAC filters.

10. Post disinfection of biologically treated effluents reduced HPC bacterial counts but increased AOC levels. The level of increase was dependent upon the type of preoxidant. However, even after post disinfection, prechlorinated water had lower AOC levels than preozonated water.

ACKNOWLEDGMENTS

The American Water Works Service Company, Inc. gratefully acknowledges the cooperative effort of the New Jersey Department of Environmental Protection (NJDEP) who provided personnel to operate the pilot plant. Operators included : Allan Dillon, Brian Keune, Michael Dillon, Larry Cyr, Joan Kryak, Theresa Treadwell, Mark Hubal, Maria Valvis, Jim Sleigh, Harold Nebling, Mira Desai, Paul Galek, James Montgomery, Nasir Butt, and Chuck Viviani. Barker Hamill helped organized the NJDEP participation in the study.

We thank Brian Schwartz and Tony Ranu for performing the chemical and microbiological analyses. We appreciate the support of the staff of the New Jersey American Water Company, Swimming River Treatment Plant, during the project. This study was funded by the American Water System, Voorhees, NJ.

REFERENCES

- AMERICAN PUBLIC HEALTH ASSOCIATION. 1985. *Standard Methods for the Examination of Water and Wastewater*, 16th ed. American Public Health Association.
- BABLON G., VENTRESQUE C., AIM R.B. 1988. Developing a sand-GAC filter to achieve high-rate biological filtration. *J. Amer. Water Works Assoc.* 80, 47-53.
- BECKER W. C., LEE R.G., MOSER R.H.. 1989. Evaluation of the potential use of ozone in the American System. Report to the American Water Works Service Company, Inc., Voorhees, NJ.
- BORDNER R., WINTER J. (eds). 1978. *Microbiological Methods for Monitoring the Environment*. EPA-600/8-78-017. US Environmental Protection Agency, Cincinnati, OH.
- CAMPER A.K., LECHEVALLIER M.L., BROADAWAY S.C., McFETERS G.A.. 1985a. Evaluation of procedures to desorb bacteria from granular activated carbon. *J Microbiol. Methods*, 3, 187-198.
- CAMPER A.K., LECHEVALLIER M.L., BROADAWAY S.C., McFETERS G.A.. 1985b. Growth and persistence of pathogens on granular activated carbon filters. *Appl. Environ. Microbiol.* 50, 1378-1382.
- CHANG S.D., SINGER P.C. 1991. The impact of ozonation on particle stability and the removal of TOC and THM precursors. *J. Amer. Water Works Assoc.* 83 (3), 71-79.
- COMMITTEE REPORT, AWWA. 1981. An assessment of microbial activity on GAC. *J. Amer. Water Works Assoc.* 73, 1447-454.
- COOPERATIVE RESEARCH REPORT. 1988. The Search for a Surrogate. AWWA Research Foundation. Denver, CO.
- CROWE P.B., BOUWER E.J. 1987. *Assessment of Biological Processes in Drinking Water*. AWWA Research Foundation. Denver, CO.
- DE LEER E.W.B. et al. 1985. Identification of Intermediates leading to chloroform and C-4 diacids in the chlorination of humic acid. *Envir. Sci. Technol.*, 19, 512.
- FAUST S.D., ALY O.M. 1987. *Adsorption Processes for Water Treatment*. Butterworths Publishers, Boston, MA.
- GRAESE S.L., SNOEYINK V.L., LEE R.G. 1987. *GAC Filter-Adsorbers*. American Water Works Association, Denver, CO.

- HUCK P.M., TOFT P. 1987. *Treatment of Drinking Water for Organic Contaminants*. Pergamon Press. New York, NY.
- HUCK P.M. 1990. Measurement of biodegradable organic matter and bacterial growth potential in drinking water. *J. Amer. Water Works Assoc.*, 82 (7), 78-86.
- HUDSON L.D., HANKINS J.W., BATTAGLIA M. 1983. Coliforms in a water distribution system: a remedial approach. *J. Amer. Water Works Assoc.*, 75, 11, 564-568.
- KUROSAWA Y., MAGARA Y., ALZAWA T., MUSASHI M., ITOH M. 1987. Studies on biological activated carbon filter processes. pp. 433-441. Proc. Water '87; 6th Asia Pacific Regional Water Supply Conference, Bangkok, Thailand.
- LANGLAIS B., RECKHOW D.A., BRINK D.R. 1991. *Ozone in Water Treatment, Applications and Engineering*. Lewis Publishers, Inc., Chelsea, MI.
- LECHEVALLIER M.W., BABCOCK T.M., LEE R.G. 1987. Examination and characterization of distribution system biofilms. *Appl. Environ. Microbiol.* 53, 2714-2724.
- LECHEVALLIER M.W., OLSON B.H., McFETERS G.A. 1990. *Assessing and Controlling Bacterial Regrowth in Distribution Systems*. AWWA REsearch Foundation. Denver, CO.
- LECHEVALLIER, M.W. SCHULZ, W., LEE, R.G. 1991. Bacterial nutrients in drinking water. *Appl. Environ. Microbiol.* 57, 857-862.
- LI A.Y., DIGIANO F.A. 1983. Availability of sorbed substrate for microbial degradation on granular activated carbon. *J. Water Pollut. Control Fed.* 55, 392-399.
- LOWTHER E.D., MOSER R.H. 1984. Detecting and eliminating coliform regrowth. Proc. AWWA Water Quality Technol. Conf. Denver, CO.
- LUDWIG F. 1985. The occurrence of coliforms in the Regional Water Authority water supply system. A report submitted by the South Central Connecticut Regional Water Authority, New Haven, CT.
- OLIVIERI V.P., BAKALIAN A.E., BOSSUNG K.W., LOWTHER E.D. 1985. Recurrent coliforms in water distribution systems in the presence of free residual chlorine. pp. 651-666. In: R.L. Jolley, R.J. Bull, W.P. Davis, S. Katz, M.H. Roberts Jr. and V.A. Jacobs (eds), *Water Chlorination, Chemistry, Environmental Impact and Health Effects*. Lewis Publishers, Inc., Chelsea, MI.
- PREVOST M., DESJARDINS R., COALLER J., DUCHESNE D., MAILLY J. 1990. Comparison of biodegradable organic (130C) techniques for process control. Proc. AWWA-WQTC, San Diego, CA.
- REILLY J.K., KIPPEN J.S. 1983. Relationship of bacterial counts with turbidity and free chlorine in two distribution systems. *J. Amer. Water Works Assoc.* 75, 309-312.
- RITTMANN B.E., HUCK P.M. 1989. Biological treatment of public water supplies. *CRC Reviews in Environ. Control.* 19, (2), 119-184.
- ROLLINGER Y., DOTT W. 1987. Survival of selected bacterial species in sterilized activated carbon filters and biological activated carbon filters. *Appl. Environ. Microbiol.* 53, 777-781.
- SHELLART J.A. 1986. Disinfection and bacterial regrowth: some experiences of the Amsterdam Water Works before and after stopping the safety chlorination. *Water Supply*, 42, 217-225.
- SINGER P.C., CHANG S.D. 1989. Correlations between trihalomethanes and total organic halides formed during water treatment. *J. Amer. Water Works Assoc.* 81, (8): 61-65.
- SONTHEIMER H., HUBELE C. 1987. The use of ozone and granular activated carbon in drinking water treatment. pp.45-66. In P.M. Huck and P. Toft (eds.), *Treatment of Drinking Water for Organic Contaminants*. Pergamon Press. New York, NY.
- SYMONS J.M., STEVENS A.A., CLARK R.M., GELDREICH E.E., LOVE JR. O.T., DEMARCO J. 1981. *Treatment Techniques for Controlling Trihalomethanes in Drinking Water*. EPA-600/2-81-156, US Environmental Protection Agency, Cincinnati, OH.
- SYMONS J.M., BELLAR T.A., CARSWELL J.K., DEMARCO J., KROPP K.L., ROBECK G.G., SEEGER D.R., SLOCUM C.J., SMITH B.L., STEVENS A.A. 1975. National organics reconnaissance survey for halogenated organics. *J. Amer. Water Works Assoc.* 67, (11): 634-647.

- USEPA. 1989a. National Primary Drinking Water Regulations ; total coliforms (including fecal coliforms and *E. coli*) ; final rule. *Federal Register*. 54, (124), 27544-27568.
- USEPA. 1989b. National Primary Drinking Water Regulations ; filtration and disinfection ; turbidity, *Giardia lamblia*, viruses, *Legionella* and heterotrophic bacteria ; proposed rule. *Federal Register*. 54, (124), 27486-27541.
- VAN DER KOOIJ D., *HIJNEN A.M., KRUIHOF J.C. 1989. The effects of ozonation, biological filtration and distribution on the concentration of easily assimilable organic carbon (AOC) in drinking water. *Ozone Sci. Engineer.*, 11, 297-311.
- VAN DER KOOIJ D., VISSER A., HIJNEN W.A.M. 1982. Determining the concentration of easily assimilable organic carbon in drinking water. *J. Amer. Water Works Assoc.* 74, 10, 540-545.
- VAN DER KOOIJ D., HIJNEN A.M. 1985. Measuring the concentration of easily assimilable organic carbon in water treatment as a tool for limiting regrowth of bacteria in distribution systems. Proc. AWWA Water Quality Technol. Conf. Dec. 8-11, Houston, TX.
- VAN DER KOOIJ D. 1987. The effect of treatment on assimilable organic carbon in drinking water. pp. 317-328. In : P.M. Huck and P. Toft (eds), Proc. Second National Conference on Drinking Water, Edmonton, Canada, April 7-8, 1986. Pergamon Press, London.
- WHITE G.C. 1986. *Handbook of Chlorination*. Van Nostrand Reinhold Company, New York, NY.